

Siren-Based Alarm System

Installation · Programming · Operating

Keep this manual safe for reference and future maintenance

Introduction

General System Overview

Thank you for choosing the Yale Wireless Security Alarm System. This simple to install system has been designed with the user in mind.

The siren has a sounder and strobe LEDs to attract attention.

Number of devices

You can install up to 20 devices in the system. As well as extra door/window contacts, PIRs and keypad remote controls, you can add smoke detectors, keyfob remote controls and help buttons.

Long battery life

The system has a typical battery life of 2 years or more before they need changing. Regular testing and battery changes (when notified by the system) will ensure reliability and peace of mind. Please note that alkaline batteries and the correct type of coin cells must be used as replacements.

Tamper proof system

Each part of the system is 'tamper' protected. Any unauthorised tampering with the system will result in an alarm. This feature can be turned off by the user when a battery change is required.

Entry/Exit feature (for System with remote keypad)

The system has a 20 second entry/exit time. This feature allows you time to leave the home when arming the system. Upon entering, the feature allows time to disarm the system without causing an alarm.

Take care of your safety

Display extreme caution when using ladders or steps, please follow manufacturer instructions. Be careful when using hand and power tools and follow the manufacturers' guidelines when using them. Take care that the correct tools are used. Wear goggles or protective clothing where required.

The external Siren is extremely loud, please ensure you replace the cover and retreat to a safe distance before testing.

Contents

Contents

1	Location planning	2
2	Unpacking the system	3-4
3	Programming the system	5
4	Mounting alarm devices	6-8
5	Using the system	9-10
	Adding accessories	11
	Changing the batteries	12
	Specifications	14
	Trouble shooting	15

Recommended Installation Sequence

We recommend you follow the easy start sequence, headings numbered **1-5**.

Information and illustrations are subject to change within this document. Yale reserves the right to alter the specification and product design at anytime without notice. Yale® is a registered trademark. © 2010 ASSA ABLOY. All rights reserved.

1 Location planning

Work out the best places to locate the devices for maximum protection. Having chosen the locations do not mount at this stage.

Operating range

All devices must be within 30 metres of the siren unit and must not be mounted on or near large metal objects. Avoid obvious sources of electrical interference such as fridges and microwave ovens.

Tamper switches

When mounting devices ensure that any tamper switches close fully. On uneven surfaces it may be necessary to place packing behind the switch for reliable operation.

Help button accessory

The help button provides extra protection for you and your family. When help is needed the button can activate your alarm immediately - even when the system is disarmed.

- Mount on bedroom wall or by the front door
- Not clearly visible to an intruder
- Easily accessible
- Out of reach of children

Smoke detector

- Mount in the middle of the ceiling at the top of a stairwell, or on the centre of hallway ceilings where smoke would most likely be detected.
- Do not mount in corners or above cooking appliances and heaters.
- Install additional detectors if there are closed doors preventing smoke from reaching detectors.

Siren

Choose a position on an external wall where the siren would be most prominent. Mount as high as possible, out of easy reach. (Round shaped siren shown)

Door/Window contacts

Use one door/window contact on a door that is used as the main point of entry and exit, usually your front door. The other door/window contact can be used to protect another entry point such as a rear door.

- Mount as high as possible.
- Do not aim a PIR at this door or window.

Keyfob remote control accessory

Can be used outside the premises and kept on your keyring.

Keypad remote control

- The keypad should be sited next to the main point of entry/exit so that the system can be disarmed/armed within 20 seconds of entering/leaving the premises.
- Ensure that the keypad is not visible from the outside of the premises.
- Mount at chest height for ease of use.
- Designed for indoor use only.

PIR movement detectors

- Mount in a position such that an intruder would normally move across a PIRs field of view.
- Height should be between 1.7 and 2.3 metres above floor level.
- Location in a corner will ensure wider room coverage.
- Do not mount a PIR where its field of view will be obstructed e.g. by curtains, ornaments etc.
- Do not point directly at sources of heat e.g. fires or boilers, and do not position directly above radiators.
- Avoid mounting a PIR directly facing a window.
- Do not point a PIR at a door protected by a door/window contact.

Extend the system

Extend the system in the future to increase your security or as your needs change.

For example, add extra PIR detectors in bedrooms and extra door/window contacts.

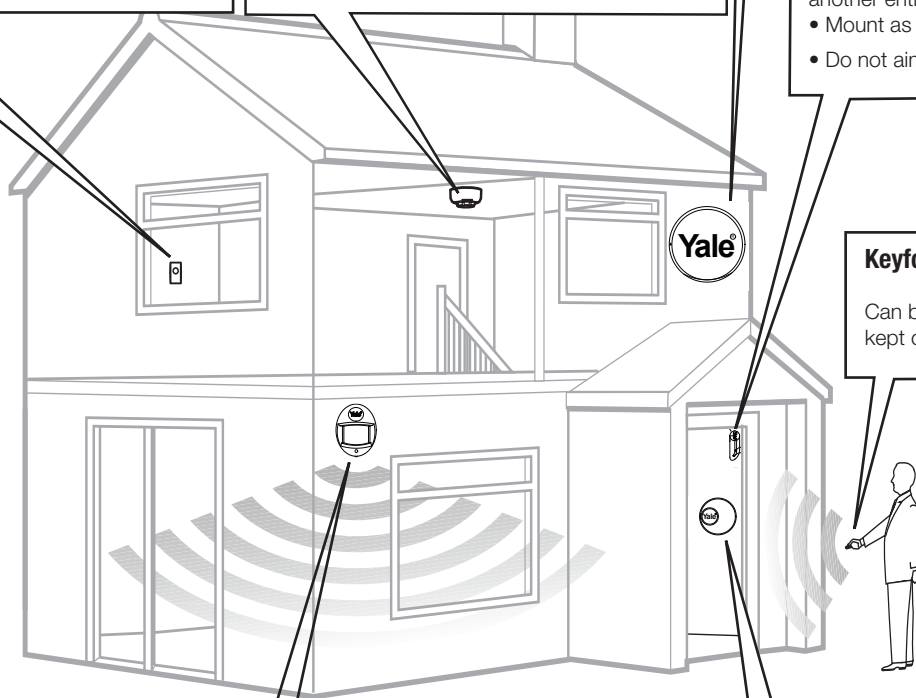

2 Unpack all the parts on a table top

The easiest way to get to know the system and get it up and running quickly is to get all the devices and accessories programmed on a table top before locating and mounting them.

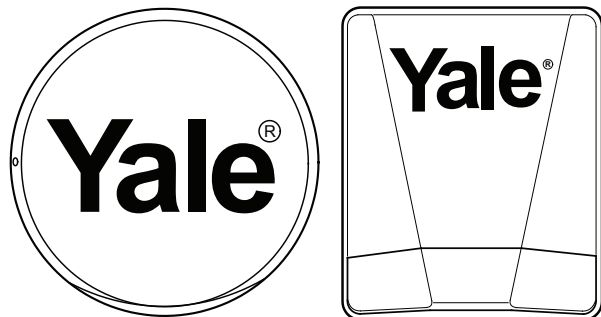

Siren

The siren comes in two shapes, square shaped and round depending on the kit purchased. The operation and programming of the sirens are identical, only the case is different.

WARNING

The siren is very loud, be prepared! Take care not to activate the siren tamper switch unnecessarily.

- 1 Remove the cover by unscrewing the single screw located on the lid.
- 2 Square siren only: remove the left hand cover (not battery compartment).
- 3 Move the programming switches to Master On (switch 4) and Clear On (switch 1).

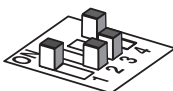

Clear

- 4 Switch the power switch to on
(The 3 strobe LEDs will now flash side to side with one short beep.)

- 5 Move the Clear switch to the Off position.



NORMAL

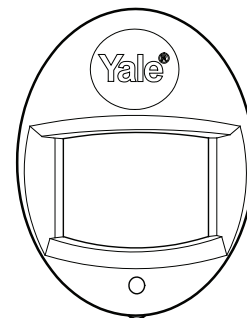
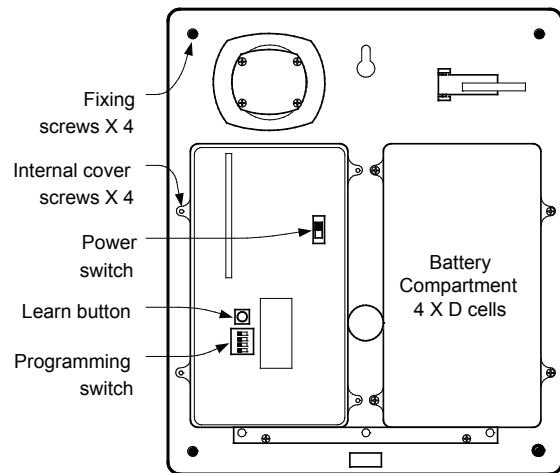
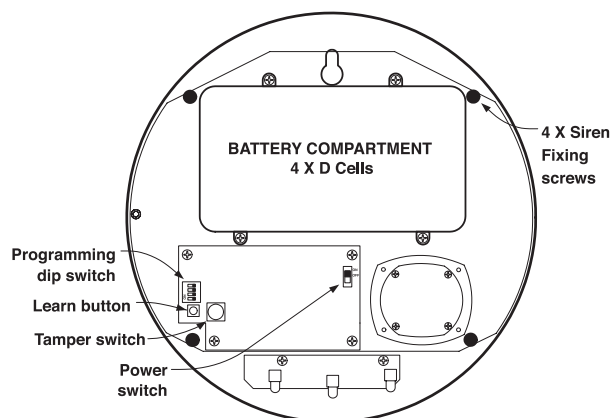

PIR movement detectors

- 1 Pull out the plastic pull tab on the back of the PIR. This will activate the batteries.

(A red light can be seen flashing through the lens. This will last for 30 seconds indicating the component's initiation.)

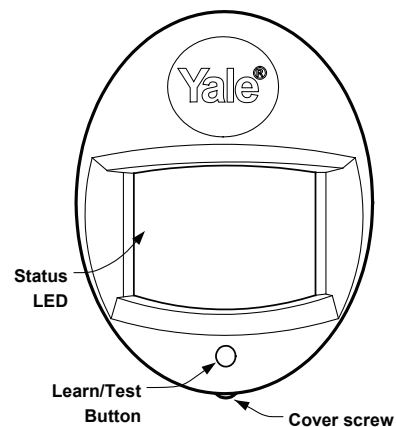

Keypad remote control

- 1 Pull out the plastic battery saver tab at the back of the remote keypad. This will activate the batteries.

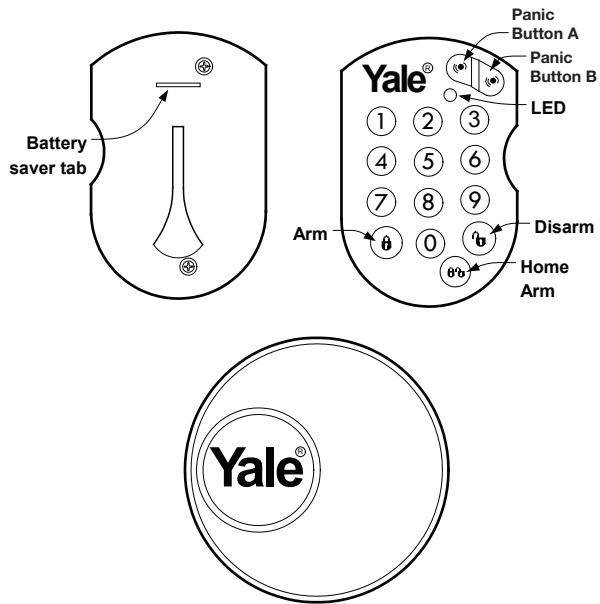

Door/window contacts

- 1 Pull out the plastic pull tab found on the side of the main unit. This will activate the battery.

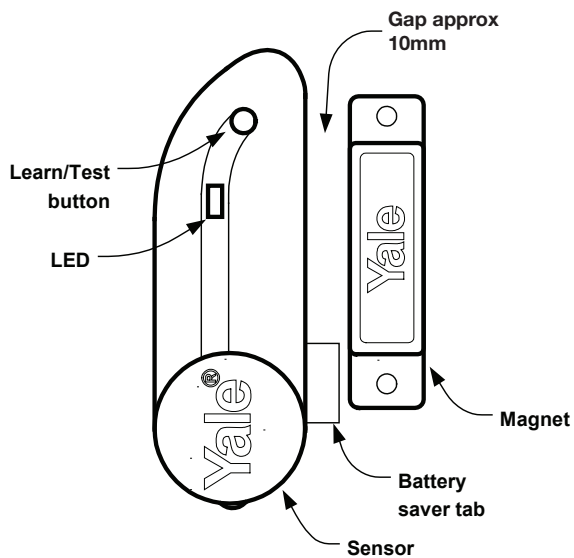

Keyfob remote control accessory

- 1 Open the battery compartment using a coin by turning the cover in the direction of the big arrow so the cover small arrow is next to round dot.
- 2 Insert battery and replace cover.

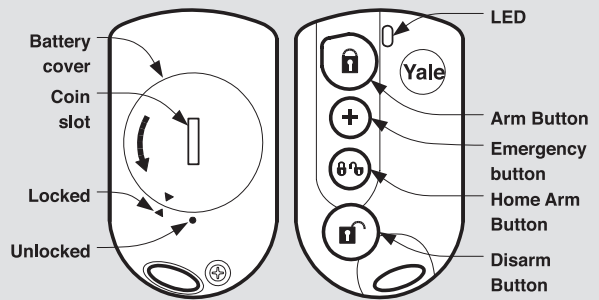

Smoke detector accessory

- 1 Remove the cover and insert the four AAA batteries as shown
- 2 The Smoke detector will now enter into self-calibration mode for 10 minutes. It will resume normal operation after this period.

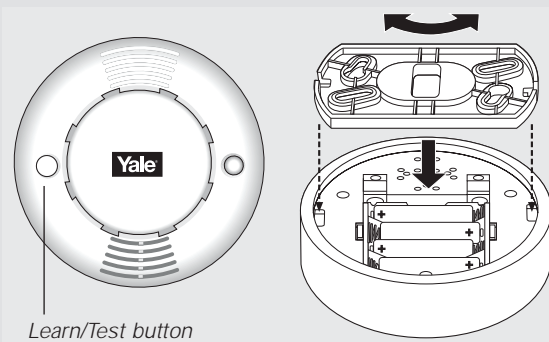

Help button accessory

- 1 Remove the cover by loosening the fixing screw and insert the 12V battery (supplied) as shown. Please ensure you observe battery polarity.

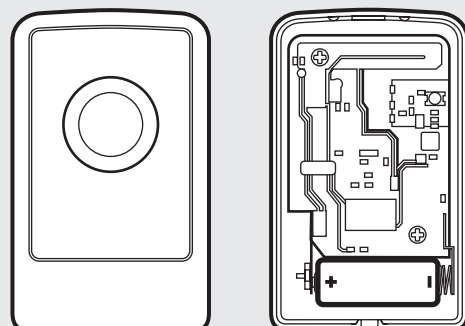

3 Programming the Siren-based system (without control panel)

The siren is the heart of the system. All components must be recognised by the siren.

1 Entering Learn mode:

- Press and hold **Siren learn button** for 1 second.
(A short beep will follow with the outside LEDs flashing once.)

i System is now in learning mode for 3 minutes. Proceed to the following steps to add in additional devices (20 devices maximum) within this time period.

If device learning takes more than 3 minutes and the learn mode expires, the siren learn button will need to be pressed again to add more devices.

2 Adding devices:

i When any device is learnt-in, the siren will beep once and the outside LEDs will flash once in acknowledgement.

Remember to press any buttons and keys firmly for 1 second to send a learn-in radio signal.

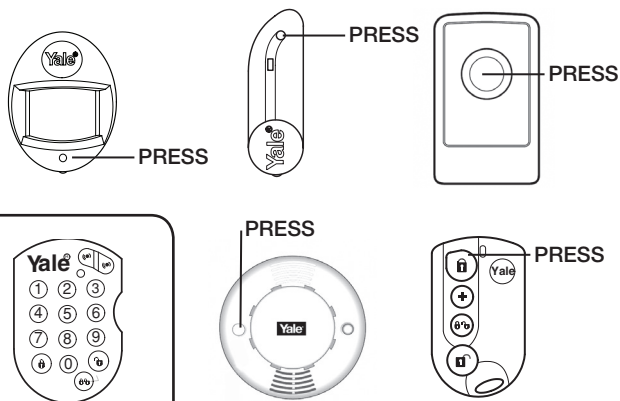

Keypad (All keys should be pressed in quick succession.)

- 1 Press **Panic button A** and enter **pincode** (please note that the default pincode is 0000).
(The LED will now be flashing. System is now in setting mode)
- 2 Press **Panic button A** and enter **8**
(The keypad will confirm with two fast flashes that it is in "Siren as master" mode.)
- 3 Press **Panic button A** then **1** to send learn-in signal.
- 4 Press **Panic button A** then **2** The press **disarm** twice to quit. *(The siren will beep in acknowledgment).*
(The keypad LED will now stop flashing. If not, press "disarm" twice again)

3a Exiting Learn mode:

- Press the **Siren Learn button** to exit the learn mode
- The PIR and Door Contact may trigger the Siren at this point. *(Do not turn the siren power off.)*

3b Disarming Siren:

- Press **disarm** followed by 0000.
(The siren will beep and flash twice.)

Adjusting Alarm ringing duration:

4

- Dip switch 3 determines the alarm ringing duration length. Switch left for 4 minutes or right for 10 minutes (default) siren duration.

Enable/disable interference detection:

5

- Set Dip switch 2 for interference detection. Switch left to enable and right to disable (default).

i This unit is equipped with the latest type of radio receiver using AM radio technology. If the system is armed any criminal attempt to interfere detector transmissions will trigger an alarm. If the alarm is frequently triggered by interference there may be high levels of unusual radio signals in your area. Some kinds of electronic equipment can generate this kind of radio interference. In the unlikely event of you experiencing problems with interference, it is recommended that you switch interference detection off.

Programming is now finished and the system is ready to be installed.

4 Mounting alarm devices

Before mounting the keypad and siren ensure that the system tamper is disabled as described below.

Disabling the system tamper

i Before mounting it is important to disable the system tamper to avoid the siren sounding an alarm.

Using the Keypad:

- Press **Panic button A** and enter **pincode** (factory default is 0000) to enter test mode, press **Panic button A** then **2** to send "Tamper Off" signal, Then press **disarm** twice to quit. (The keypad led will now stop flashing if not press disarm twice again. *The siren will beep in acknowledgement.*)

Using the Keypad:

- Press and hold down **Arm** and **Home** buttons for 5 seconds. *(The siren will beep in acknowledgement.)*

i The tamper function is now disabled for one hour. If more time is required, simply repeat the above step.

Mounting the siren

Ensure the tamper switch is fully depressed when the siren is mounted. If there is a gap, pack with a suitable spacing material.

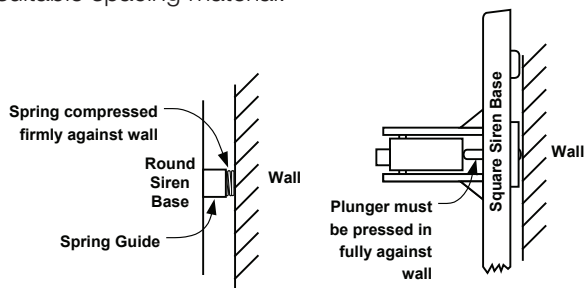

- 1 Using the large screws and wall plugs provided, mount on the desired wall through the 4 mounting holes.
- 2 Fix the siren cover with the securing screw.

Testing whether the siren is fitted correctly:

- 1 Press **Arm** with the Keypad/Keyfob.
- 2 If there are 5 short beeps when armed, the tamper switch is NOT fully depressed and will need to be

i Before you make the adjustment:

- **Disarm your system** using your keyfob (Press disarm) or keypad (Press disarm followed by the pincode).
- **Disable the system tamper** as described on the left.
- If there is a gap between the wall and the tamper switch mechanism pack with a suitable spacing material.
- Once finished repeat the step 1 and 2 above.

- 3 If there is one short beep and flash when armed, the siren is mounted correctly and the siren installation is complete. Disarm the system and disable the tamper as described in the information box above.

Mounting other devices

Find a location where the device is to be mounted, see section "Location Planning" for suggestions.

i Before proceeding to mount the devices physically, it is useful to check that it is not out of radio range by doing a simple range test. Please ensure the system tamper is disabled.

- **Keypad:** Hold the keypad in the desired location and arm and disarm the system. *(The siren will beep as confirmation.)*
- **Help button:** To prevent an alarm being triggered, put the siren into learn mode first (see page 5, section 1). Hold the device in the desired location and press the emergency button. *(The siren should respond with a single beep.)*
- **All other devices:** Hold the device in the desired location and press the learn/test button. *(The siren should respond with a single beep.)*

When you are satisfied that the devices work in your chosen locations, proceed with the installation as described in the next page. If the siren does not respond, the location may be out of range, try alternative locations until reliable radio contact is obtained.

Mounting the Keypad:

- 1 Drill holes into the wall using the fixing slots as a template.

- 2 Fit wall plugs into the wall and fix cradle with the screws provided.

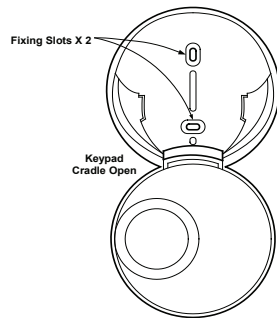

- 3 Slide the keypad into the cradle
- 4 Close the cradle cover so the logo is facing you

Mounting the PIR

- 1 Open the PIR by loosening the bottom screw. Knock out the relevant holes on the base where the plastic is thinner. The center two knockout holes are for flat wall mounting while the 4 side holes are for corner mounting.

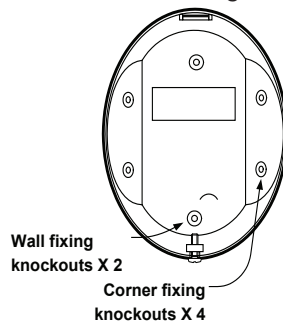

- 2 Drill holes into the wall using the knockout holes on the base as a template.
- 3 Fit wall plugs and secure the PIR base with the screws provided.
- 4 Fit the PIR back together and tighten bottom screw, the PIR installation is complete.

i The PIRs have a built-in sleep timer to save battery power. If there is no movement in front of the PIRs for 1 minute, the PIRs will become 'ready to signal' and movement will now be reported. The PIRs will sleep for 1 minute after reporting.

Any movement detected in sleep time will not be reported and will extend the sleep period by a further 1 minute.

Mounting the door/window contact

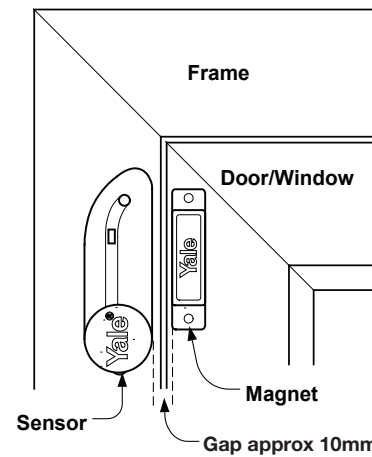

- 1 Find a location where the door/window contact is to be mounted. It should be mounted between the door/window frame and the door/window as shown at the top of the opening. The magnet is to go on the door/window while the sensor is to be placed on the frame. Windows can be protected in a similar way to doors. Make sure the tamper switch spring is fully depressed.

i The gap between the magnet and sensor should be approximately 10mm when closed (depending upon the actual environment).

Simple test to see whether the magnet is in range of the sensor: hold the magnet and sensor in place and then pull them apart. If the sensor LED lights up it implies the two items are within range.

-Mounting using adhesive pads

- 1 Clean the mounting surface with a suitable degreaser agent.
- 2 Remove the protective film from one side of the adhesive pad and apply to the back of the sensor and magnet
- 3 Remove the remaining protective film and firmly press into place.
- 4 Test sensor by pressing the test button and opening and closing the door/window. The LED should light when the door/window is opened. Installation is complete.

-Mounting using screws and wall plugs

1 Loosen the bottom screw and open the door/window contact.

2 Knock out the holes on the base as shown.

3 Drill holes into the mounting surface using the holes in the knockouts on the base as template.

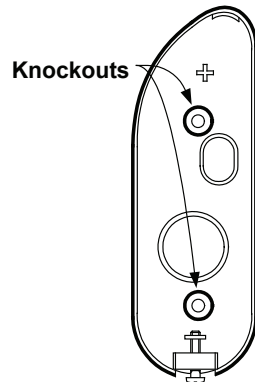

4 Fit wall plugs (if required) and secure with the screws provided.

5 Fit sensor back together and tighten screw.

6 Test sensor by pressing the test button and opening and closing the door/window. The LED should light when the door/window is opened. Installation is complete.

i The tamper switch will automatically reactivate after one hour. Alternatively you can enable the tamper switch manually (optional).

See Page 10, Table 1 and Table 2 for manual tamper switch reactivation using Keypad or Keyfob.

Mounting the Help button

1 Break through the knockouts (where the plastic is thinner).

2 Using the holes as a template, drill holes in the surface and insert wall plugs if fixing into plaster or brick. Screw the rear case to the wall.

3 Replace the cover and tighten the screw.

Mounting the Smoke Detector

1 The base has two mounting slots. Using the slots as a template, drill holes and insert the wall plugs if fixing to plaster. Screw the rear case to the ceiling using the screws provided.

2 Replace the cover.

5 Using the system

Arm and disarm the system and practice using it. Trigger the alarm by arming the system and opening protected doors/windows and walking past PIRs. Now's the time to set your pin code and show the rest of the family how simple it is to use.

Arming the system

Keypad/Keyfob: Press **arm**
(The siren will beep and flash once. There will be no audible countdown.)

- i** • **Keypad** will arm the system with a 20 seconds exit period. All detectors will be ignored (except for the tamper switches). The system can be armed when inside the protected area of your premises.
- **Keyfob** will arm the system instantly without a 20 second exit delay. Any detector activated afterwards will trigger an instant alarm. The system should be armed when outside the protected area of your premises.

Disarming the system

Keypad: Press **disarm** followed by your **pincode**.
Keyfob: Press **disarm**
(The siren will beep and flash twice.)

- i** • **Keypad:** If the system has been armed with a keypad there will be a 20 second entry period started when the first detector is activated (usually a window/door contact on the main point of entry). During this entry period all detectors will be ignored. The siren will beep once when the first detector is triggered.
- If the system is not disarmed before the entry period expires, the alarm will be activated.
- The system does not have an audible countdown during the entry period.
- **Keyfob:** If the system has been armed with a keyfob there will be no 20 second entry period and any detector activation will give an instant alarm.
- The system should be disarmed from outside the protected area of your premises.

Stopping the Siren

Keypad: Press **disarm** followed by your **pincode**.
Keyfob: Press **disarm**
(The siren will be silenced and then beep and flash twice.)

Changing your keypad PIN code

- 1 Enter setting mode: Press the **Panic button A**, followed by entering the current **pincode** (factory default code is 0000).
(The LED will now flash continuously.)
- 2 Press **panic button B**.
- 3 Enter new 4-digit **pincode**.
- 4 Press **Arm** button to confirm.
- 5 Exit setting mode: Press **disarm** twice to quit the changing code process. Or wait for 5 minutes for the keypad to quit test mode automatically.
(The LED will now stop flashing.)

- i** • If the PIN code doesn't change, repeat the above procedure quickly without gaps.
- The keypad will lock out for one minute after four failed attempts to enter the pincode.

Tamper alarm warning

If any device tamper switches are disturbed a tamper alarm will be activated with the siren sounding and the strobe flashing. The alarm can be silenced as described in "Stopping the Siren".

- i** If there is a persistent siren tamper fault then a series of 5 pips and flashes will be given when the system is armed, then the siren should be checked for any mounting problems and if the siren lid is secure.

Previous alarm warning

Should there be an alarm that was triggered and expired (while the user was away), the siren will sound and flash for 3 seconds after disarming (user returning home).

** Warning: should this happen the intruder could still be in the premises.*

My PIN code:

(write your pincode here so you don't forget it)

Using the help button

Activate: Press and hold **panic button** for 2 seconds, the LED will light briefly and the siren will be activated.

Silence: press and hold **panic button** for 10 seconds, the LED will light briefly and the siren will be silenced.



Please note that silencing the alarm with the help button does not disarm the system. If the alarm is armed prior to activation, the system will re-arm after being silenced with the help button.

Using the smoke detector

The smoke detector will indicate a fire by sounding its built-in siren, lighting the LED and activating the external siren and strobe.

-Smoke detection

When smoke is detected the device will activate for a minimum of 10 seconds with a two tone alarm and flashing LED for a local fire alarm. The detector will also activate the external siren and strobe.

- Pressing the test button when in an alarm condition will silence the alarm for 10 minutes, it will automatically resume smoke detection again after this period.
- If the smoke density is still over the alarm threshold, then the smoke detector will remain in an alarm condition and it will repeat the local fire alarm and activate the external siren and strobe again.

-Testing

Smoke detector testing should be done on a regular monthly basis. Pressing the test button will make the LED flash, the audible sounder chime and will send a radio test signal to the siren when the button is released. If nothing happens after pressing the test button then change the batteries.

-Recalibration

The smoke detector might need recalibrating after time to ensure it is working at its optimum. This is done by pressing and holding in the test button until the LED flashes and it beeps after 10 seconds. The detector will then start its self-calibration routine.

Keypad Modes: Table 1

Entering setting mode:

Press **Panic button A** followed by **pincode** (factory default is 0000). You can now select different function. (The LED on the keypad will start flashing)

Function setting:

Press **Panic button A**, followed by one of the following number key:

- 1 **Send learning/testing signal**
- 2 **Disable Siren tamper**
- 3 **Enable Siren tamper**
- 4 **Enter learn mode** (not suitable for first time set-up)
- 5 **Exit learn mode**
- 7 Keypad to work with control panel based system.
- 8 Keypad to work with siren based system.

Exiting setting mode:

Press **disarm** twice.
(The LED will now stop flashing. If not, press disarm twice again)

KeyFob Modes: Table 2

• Sending learn signal

Press any key except the emergency button.

• Siren tamper (Enable)

Press and hold down **Arm** and **emergency** for 5 seconds.

• Siren tamper (Disable)

Press and hold down **Arm** and **Home** for 5 seconds.

• Learn mode (Enter)

Press and hold down **Home** and **emergency** for 5 seconds.

• Learn mode (Exit)

Press and hold down **disarm** for 5 seconds.

Adding accessories

To provide additional protection you can add extra door/window contacts, PIRs, keyfob remote controls, keypad remote controls, help buttons and smoke detectors. These are available separately from your local stockist.

Adding devices for the first time

See section 3 (page 5) for first time system installation.

Adding devices to an already installed system

The installed system will be controlled by either a keyfob(s) or a keypad(s).

Keypad

- 1 Enter Setting mode:** Press **Panic button A** followed by the **pincode**.
(Indicated by a continuously flashing LED.)
- 2 Switch OFF system tamper:** Press **Panic button A** followed by **2**.
(The siren will beep in response.)
- 3 Enter learn mode:** Press **Panic button A** followed by **4**. *(The siren will beep and flash in response.)*
- 4 LEARNING:** Press device learn/test buttons (see section 3, step 2) to trigger learning-in signals.
(The siren will beep and flash when each device is learnt in.)
- 5 Exit learn mode:** When all the devices have been learnt in, press **Panic button A** and **5** to quit learn mode.
- 6 Switch ON system tamper:** Press **Panic button A** and **3** to rearm tamper protection.
- 7 Exit Setting mode:** Press **Disarm** twice to exit.
(The keypad LED will now stop flashing.)

Keyfob

- 1** Press the **Arm** and **Home** buttons together and continuously for 5 seconds until the LED stops flashing, to switch off the tamper while installing the new device.
(The siren will beep in response.)
- 2** Press the **Home** and **Emergency** buttons together and continuously for 5 seconds until the LED stops flashing.
(The siren will beep and flash in response.)
- 3** Press device learn/test buttons (see section 3, step 2) to trigger learning-in signals.
(The siren will beep and flash when each device is learnt in.)
- 4** When all the devices have been learnt-in press and hold the **Disarm** button to quit learn mode.
- 5** Press the **Arm** and **Emergency** buttons together and continuously for 5 seconds until the LED stops flashing to rearm tamper protection.

Changing the batteries

Always use alkaline batteries or the correct type of coin cells as replacements because any other battery can cause problems with the operation of the system. Typical life of batteries is two years. Ensure the correct steps are taken when changing batteries in tamper protected devices.

Siren

The siren will produce a series of pips and flashes when arming and disarming the system when the batteries start getting low. After the warning the batteries will have about enough energy for 1 month's normal operation before exhaustion.

- 1 Switch off tamper protection as described in section 4.

The batteries are changed as follows:

- 2 Remove the siren lid and switch off the siren power.
- 3 Unscrew the four screws on the battery compartment lid and remove.
- 4 Remove the four batteries and replace them with four fresh alkaline "D" cells.
- 5 Switch on siren power and check that the siren beeps and flashes.

Warning After the batteries have been changed the tamper will become active again, either be very careful when fitting the siren cover or switch off the tamper protection again.

- 6 Replace battery compartment lid and screws and reattach siren lid. Switch tamper protection back on.

- *Siren case tamper conditions are also signalled by a series of beeps when the system is armed, but not when the system is disarmed (low battery warning produces a series of pips when armed and disarmed), take care not to confuse the two different conditions.*

PIR

When the battery is low the LED will flash when any movement is detected. The batteries are changed as follows:

- 1 Switch off tamper protection as described in section 4.
 - 2 Loosen the case screw and remove PIR sensor from base to reveal three AAA batteries.
 - 3 Press the learn button to drain residue power.
 - 4 Insert new alkaline batteries observing correct polarity.
 - 5 Refit sensor on base and tighten bottom case screw. Switch tamper protection back on.
- *PIR case tamper conditions are also indicated by a flashing LED, check the tamper before changing the batteries.*

Door/window sensor

When the battery is low the LED will flash when the door/window is opened. The battery is changed as follows:

- 1 Switch off tamper protection as described in section 4.
- 2 Loosen the case screw and remove door/window sensor from base to reveal battery.

- 3 Using a screwdriver gently lever out the old battery.
 - 4 Insert new CR2032 coin cell with the + side uppermost.
 - 5 Press battery into holder firmly with finger and thumb until a click is heard.
 - 6 Refit sensor on base and tighten bottom case screw. Switch tamper protection back on.
- Door/window sensor case tamper conditions are also indicated by a flashing LED, check the tamper before changing the battery.

Keyfob

When the battery is low the LED will glow dimly when any key is pressed. The battery is changed as follows:

- 1 Using a coin turn the battery cover anticlockwise to the unlocked position and remove cover and battery.
- 2 Insert new CR2032 coin cell with the + side uppermost.
- 3 Replace battery cover.
- 4 Press any key and check that the LED lights.

If the LED lights the new battery installation is successful.

Keypad

When the battery is low the LED will glow dimly when any key is pressed. The battery is changed as follows:

- 1 Unscrew the two keypad case screws and remove keypad back to reveal battery.
 - 2 Using a screwdriver gently lever out the old battery.
 - 3 Insert new CR2032 coin cell with the + side uppermost.
 - 4 Press battery into holder firmly with finger and thumb until a click is heard.
 - 5 Press a number key and check that the LED lights.
- If the LED lights the new battery installation is successful, screw keypad back on and the battery change is complete.

Smoke Detector

The LED will flash and the sounder will beep every 30 seconds to signal low battery. Change the batteries as soon as possible with fresh AAA alkaline replacements.

Help Button

Remove the cover by loosening the fixing screw and insert a new 12V alkaline battery.

ASSA ABLOY Ltd.
School Street, Willenhall
West Midlands
England, WV13 3PW

EC Declaration of Conformity

We: ASSA ABLOY Ltd.
School Street
Willenhall
West Midlands
England
WV13 3PW

declare under our sole responsibility that the following product(s):

Model: HSA6010
HSA6020
HSA6021
HSA6050
HSA6060
HSA6080
HSA6090
HSA6091
HSA3045
HSA3070

is (are) in conformity with the following relevant harmonised standards:

EN 300 220-1 / V2.1.1 (2006-04)
EN 301 489 -1, / V1.6.1 (2004-12)
EN 301 489-3, / V 1.4.1 (2002-08)
EN 60 950 / 2001 + A11 + corrigendum 2004

following the provisions of Council Directive 1999/5/EC on radio equipment and telecommunications terminal equipment and the mutual recognition of their conformity,

Name: John Ward

Position: Director

Signature:



Date: 16/11/06

On behalf of ASSA ABLOY Ltd.

Specifications

All devices

Environmental conditions

-10°C to 40°C, relative humidity
70% non-condensing for all units
except the external siren. Siren:
-20°C to 50°C, relative humidity
95% non-condensing

Radio operational range

30m in a typical domestic
installation, range can vary
depending on building construction,
device positions and RF
environment

Housings ABS/polycarbonate

Siren

Siren output 104dBA sound
pressure @ 1m minimum

Radio 433.92MHz AM super
heterodyne receiver with jamming
detection

Power supply 6V, 4 x D alkaline
cells. 2 years typical service life

Passive infra red (PIR) Detector

Alarm processing Microprocessor
controlled dual edge sequential
pulse count with pulse length
discrimination

Radio 433.92MHz AM transmitter

Power supply 4.5V, 3 x AAA
alkaline cells. 2 years typical
domestic service life, 1-minute sleep
timer

Movement detection range 15m,
110°

Door/window contact

Radio Microprocessor controlled
433.92MHz AM transmitter

Power supply 3V, CR2032 lithium
coin cell. 2 years typical domestic
service life

Smoke detector

Radio Microprocessor controlled
433.92MHz AM transmitter

Power supply 6V, 4 x AAA alkaline
cells. 3 years typical domestic
service life

Tested to EN54

Keyfob remote control

Radio Microprocessor controlled
433.92MHz AM transmitter

Power supply 3V, CR2032 lithium
coin cell. 3 years typical domestic
service life

Keypad remote control

Radio Microprocessor controlled
433.92MHz AM transmitter

Power supply 3V, CR2032 lithium
coin cell. 3 years typical domestic
service life

Help button

Radio Microprocessor controlled
433.92MHz AM transmitter

Power supply 12V 23A/MN21
alkaline miniature 'lighter battery'.
3 years typical domestic service life

Troubleshooting

For online assistance, please visit: www.YaleSupport.com

Siren

Siren does not respond to keypad

- Keypad low battery or bad connection. Check battery connections and polarity, if OK replace battery.
- Siren batteries are completely exhausted. Check siren batteries by removing siren cover, if there is no tamper alarm when removed, replace batteries with new alkaline equivalents.
- Keypad not learnt-in. If siren produces a tamper alarm when the cover is removed, and keypad is OK, learn-in the keypad.

Siren produces a 3 second alarm when disarmed

- There has been a previous alarm and there might be an intruder still in the premises.

Siren produces a series of pips when armed or disarmed

- The siren has low batteries. Check that the siren produces a series of pips when arming and disarming, indicating low batteries. Change batteries with new alkaline replacements.
- The siren tamper switch has been disturbed. Check that the siren produces a series of pips only when arming, indicating a tamper condition. Check that the siren cover is firmly secured and the tamper switch plunger is in contact with the wall. If not use suitable packing material to fill gap.

Siren produces an interrupted tone when sounding an alarm

- The siren has low batteries. Change batteries with new alkaline replacements.

Keypad

The keypad LED will not light when the arm key is pressed

- Battery is completely exhausted. Change battery with CR2032 coin cell replacement.

The siren will not respond to the disarm user code

- Ensure that the keypad mode is correct by entering test mode and pressing button "A" then "8".

Forgotten user PIN code

- Remove battery and reinsert with the number "3" key pressed. The keypad will go back to the "0000" keypad code. The keypad will now have to be re-learnt into the Siren, see either "Programming the siren based system" or "Adding accessories" sections.

PIR

PIR does not respond to movement

- Previous movement has triggered the PIR sleep timer (see page 7) is preventing subsequent movement detection. Arm system and vacate protected room for at least 1.5 minutes before testing.

PIR is slow to respond

- This is normal, the PIR has sophisticated false alarm filtering that will filter out random fluctuations and responds to genuine movement across field of view, it is less sensitive walking directly towards it.

PIR gives false alarms

- Check pets have no access to protected area.
- Check that PIR is not pointed at sources of heat or moving objects, e.g. fluttering curtains.
- Check that PIR is not mounted above convector heaters or pointing directly at windows.

PIR LED flashes

- Batteries are low or the tamper switch is disturbed. Check that the tamper switch spring is making contact with base. If the tamper switch is OK, change batteries with new alkaline replacements.

PIR does not respond to movement after test/learn button has be pressed

- Batteries are completely exhausted. Change batteries with new alkaline replacements, LED will flash for 30 seconds while components initialise.

Door contact

Door contact LED flashes

- Batteries are low or the tamper switch is disturbed. Check that the tamper switch spring is making contact with the mounting surface. If the tamper switch is OK, change batteries with new alkaline replacements.

Door contact does not respond to door opening after test/learn button has been pressed

- Batteries are completely exhausted. Change batteries with new alkaline replacements
- The magnet is too far away from the door contact. Check that the gap between door contact and magnet is not greater than 8mm.



WEEE

Note: Waste electrical products and batteries should not be disposed of with household waste. Please recycle where facilities exist. Check with your local authority or retailer for recycling advice.

NoPb C E

E4 04/10

THE YALE BRAND, with its unparalleled global reach and range of products, reassures more people in more countries than any other consumer locking solution.

THE ASSA ABLOY GROUP is the world's leading manufacturer and supplier of locking solutions, dedicated to satisfying end-user needs for security, safety and convenience.