

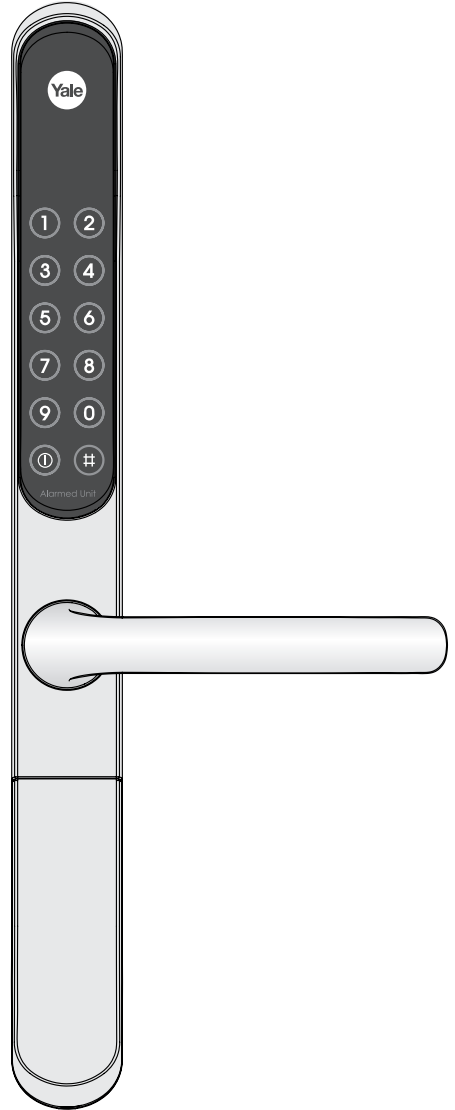

**Keyfree
Connected**

User Guide



DO NOT FIT KEYFREE UNTIL DOOR INSTALLATION IS COMPLETE.
PLEASE READ THE INSTRUCTIONS BEFORE USING KEYFREE.

KFCON-UG Rev. 001

The functions and design of this product can be changed without prior notice for performance and quality improvements.

INTRODUCTION

Thank you for choosing a Yale Keyfree product.

The new Yale Keyfree digital door lock uses the latest technology to make life so much easier.

This user manual enables you to operate the product safely and to its full potential.

Be sure to read this completely before using the Yale Keyfree product.

Keyfree Helpine:
01902 364606

Email:
smartlocks@yale.co.uk

Website:
www.yale.co.uk

CONTENTS

Introduction

Safety Precautions	4
Product Features	5

Getting Started

Lock Overview	7
Set/Change Master Code	8
Set/Delete User Code	9
Opening and locking	11
Set One Day Codes	12
Register/Delete Key Fobs	14
Change Relock Time	16
Silent Mode On/Off	18

Smart Home

Connecting to a Home Automation System	20
--	----

Extra Features

Passage Mode	22
Child Safety Mode	22
Handle Alarm	22
Intrusion Alarm	23
Incorrect PIN Lockout	24
Emergency Power	25
User Code Log	29
Key Fob log	30

Safety Precautions

Please read this carefully

Locking from the outside

When you leave your home be sure to lift up the handle in the given time so the door is fully secure.

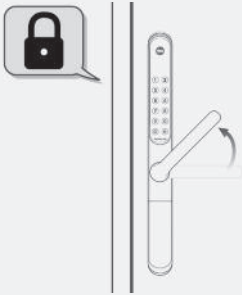

Be careful not to let any unauthorized users discover your PIN code.

Please keep your PIN code safe.



To maintain the high quality finish, clean regularly with a soft damp cloth taking care not to scratch the finish.

Do not use any chemicals when cleaning as this may affect your warranty.

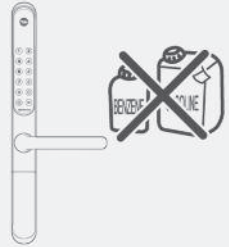

Locking from the inside

Press button & lift inner handle until. Red LED will show.

If the inner handle is not lifted to securely lock your door, the door is held on the latch only.

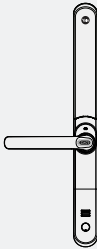

Please ensure the button is fully depressed when opening or locking your door from the inside.

If the button does not pop up when you release the lever, please slightly lift up the inside lever to make the button pop up for the best security.

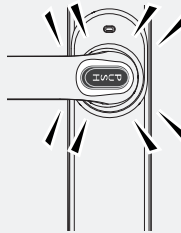

For total peace of mind, please store your back up key in a safe & convenient place.



Caution

Make sure to follow the above instructions to avoid any injuries or damage to the product .

Product Features

1. Electronic PIN Code System

You can open the door conveniently with up to 20 configurable PIN codes, allowing Keyfree access.

2. Smart Home Connectivity (Optional)

By adding the corresponding module, your Keyfree lock can be integrated with your home automation system.

3. Key Fob Entry (Optional)

A Yale key fob can be assigned to allow the lock to be unlocked remotely.

4. Emergency Backup

In the event of power failure in the lock, a 9 volt battery (PP3) can be connected to the front of the lock to provide backup power.

5. Alarmed Door Lock

The Keyfree lock has a built-in damage alarm; if the keypad area is damaged, an 80dB alarm will sound.

6. Basic Security Locking

The outside handle will automatically disengage once you have entered your home to prevent anyone from following in behind you.

7. Emergency Escape Feature

In the event of an emergency, the inside handle will always be engaged, allowing escape without first having to unlock the door.

Lock Overview

Basic Contents

The contents of this product may be subject to change without notice for performance or quality improvement.

.. Basic Contents

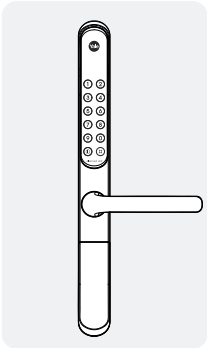

Front (Front Body)

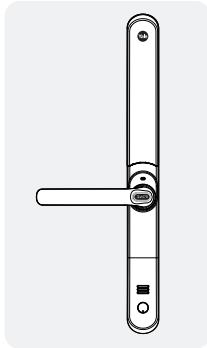

Back (Main Body)

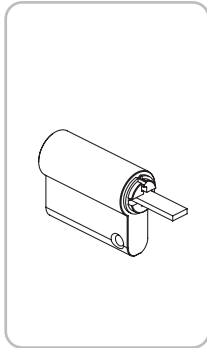

Cylinder

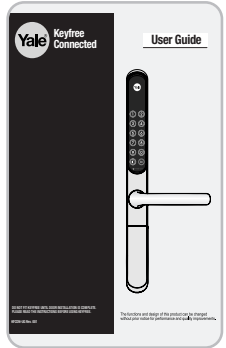

User Guide

.. Optional Accessories



Key Fob
(Optional)

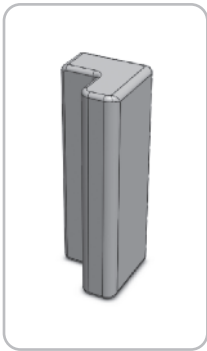

Home Automation
Module (Optional)

Lock Overview

Front (Front Body, installed on the outside of the door)

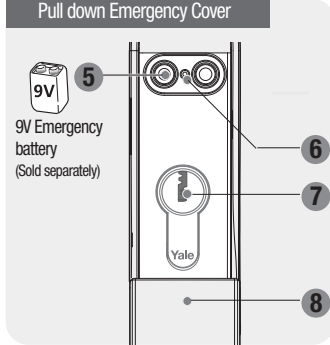
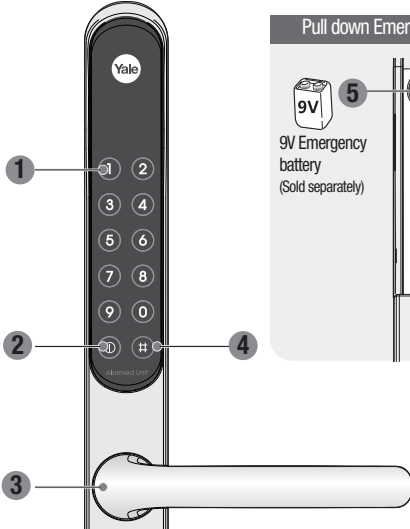

1	Keypad (10-Key)
2	Enter button
3	Lever Handle
4	# button
5	Emergency Power Supply Terminal
6	Reset button
7	Keypad
8	Emergency Cover

Back (Back Body, installed on the inside of the door)

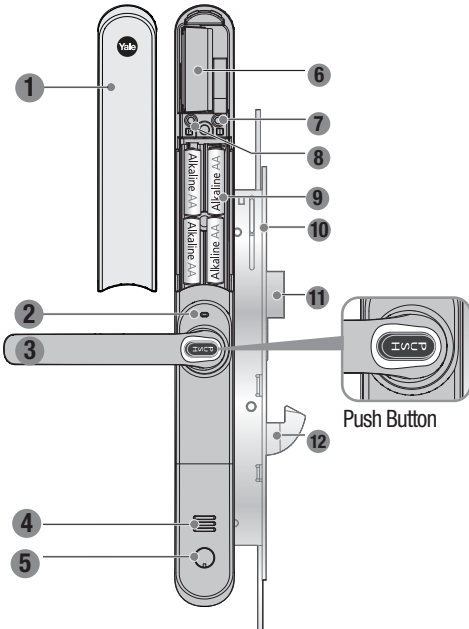





1	Battery Cover
2	LED Indicator
3	Lever Handle
4	Speaker Hole
5	Screw Hole
6	Slot for Remote control module (Optional)
7	I button
8	P Passage Mode/Button
9	1.5V AA Alkaline Batteries
10	Lock case
11	Latch Bolt
12	Dead Bolt to securely lock

Changing Master Code













Registration

The master code is the main password to the lock. As well as allowing entry through the door, it is also used to configure the lock including adding and removing users.

Step	Icon	Expected Feedback	Description
Press any button			Press any button on the keypad to begin
Enter the master code, followed by # key		2 tone beep	If you are setting the code for the first time the default is 123456.
Select the [1] button followed by # key		2 tone beep	You are now in the lock's menu, choose option number 1 to change the master code.
Enter a new master code			The master code must be 6 digits
Press the # button		Voice saying "completed"	This completes the master code setup.

Setting a User Code

The lock can hold up to 20 unique user codes, each one has a slot in the locks memory from 1 to 20. If a new code is written to a slot that already holds a code it will overwrite it. Because of this it is important to record which codes are stored in each slot. Please use the section in the back of the book to record this.

Step	Icon	Expected Feedback	Description
Press any button			Press any button on the keypad to begin
Enter the master code, followed by # key	 	2 tone beep	If you have forgotten the master code please see the resetting the lock section of the manual.
Select the [2] button followed by # key	 	2 tone beep	You are now in the lock's menu, choose option number 2 to select the user code setup.
Press the [1] button and then #	 	2 tone beep	Option number 1 adds or modifies a user code
Enter the slot number for the user code followed by # key	 		This is the number of the slot in memory where the code will be saved (1-20)
Enter the new user code followed by # key	 	3 tone ascending beep	The user code can be between 4-10 digits
Press the # button to finish.		Voice saying "completed"	The user code will now be added to the lock.

To add multiple codes please complete the above instructions, record that the memory slot has been filled in the user code log at the back of this guide, then repeat this process.

Deleting a User Code

To stop a user having access their code will need to be deleted. Before doing this you will first need to know which slot in the locks memory their code is in. Please see the user code log at the back of the guide.

Step	Icon	Expected Feedback	Description
Press any button			Press any button on the keypad to begin
Enter the master code, followed by # key		2 tone beep	If you have forgotten the master code please see the resetting the lock section of the manual.
Select the [2] button followed by # key		2 tone beep	You are now in the lock's menu, choose option number 2 to select the user code setup.
Press the [2] button and then #		2 tone beep	Option number 2 deletes a user code
Enter the slot number for the user code followed by # key		3 Tone Ascending beep	This is the number of the slot in memory where the code will be saved (1-20)
Press the # button to finish.		Voice saying "completed"	The user code will now be deleted from the lock.

Opening & Locking

Securely Locking Your Door

- Inside:** Press push button & lift the handle.
This can be done anytime and will always fully secure your door.
- Outside:** Close the door and lift up the handle within the set connection time
Once the lever disengages you must enter your PIN or press any button on the key fob and lift up the lever within the connection time to securely lock your door.

Unlocked Front handle engage



Locked

Front handle not engaged after the outside handle relocks



PIN

(Optional)



If the time expires you need to re-engage the handle to securely lock your door. You can re-engage by pressing the remote, pressing the inner lever down or entering your pin.

Exception : In the Passage mode, the handle is operable all the time.

The automatic relock time can be varied by user setting. Refer to section "settings".



IMPORTANT Your door is only securely locked when the inside lever is lifted up & red LED shows.

Opening Your Door

PIN Code

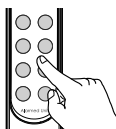

Press any button

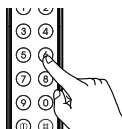

Enter registered PIN code

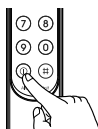

Press (Enter) button

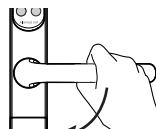

Press the outer handle down

Remote Control (Optional)

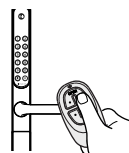



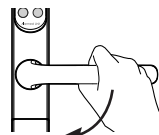

Simply press any button on the key fob



Press the outer handle down







Setting a One Day Code

The one day code is a code that will automatically expire after 24 hours. This allows short term access to be granted to someone.

Step	Icon	Expected Feedback	Description
Press any button			Press any button on the keypad to begin
Enter the master code, followed by # key		2 tone beep	If you have forgotten the master code please see the resetting the lock section of the manual.
Select the [5] button followed by # key		2 tone beep	You are now in the lock's menu, choose option number 5 to enter the one day code settings.
Enter the new user code		2 tone beep	The user code must be 4 digits
Press the # button to finish.		Voice saying "completed"	The code will now be active for 24 hours











Deleting a One Day Code

A one day code can be deleted if it is no longer wanted. If not it will expire at the end of the 24 hour period.

Step	Icon	Expected Feedback	Description
Press any button			Press any button on the keypad to begin
Enter the master code, followed by # key	 	2 tone beep	If you have forgotten the master code please see the resetting the lock section of the manual.
Select the [5] button followed by # key	 	2 tone beep	You are now in the lock's menu, choose option number 5 to enter the one day code settings.
Press the # button to finish.		Voice saying "completed"	Press the # to confirm code deletion.

Register Key Fob











Yale key fobs allow you to open the lock at a distance of up to 15 metres. This requires both the Yale key fob and the corresponding lock module to work. Up to 5 key fobs can be registered on 1 lock, and like the user codes they each have their unique slot in the lock memory. Adding a new fob into a slot that already contains a fob will override it.

Step	Icon	Expected Feedback	Description
Press any button			Press any button on the keypad to begin
Enter the master code, followed by # key	 	2 tone beep	If you have forgotten the master code please see the resetting the lock section of the manual.
Select the [3] button followed by # key	 	2 tone beep	You are now in the lock's menu, option 3 contains the key fob settings.
Select the [1] button followed by # key	 	2 tone beep	This puts the lock into fob add mode
Enter the slot number for the fob followed by #		2 tone beep	Select the number of the slot in memory where the fob will be saved (1-5)
Push both unlock buttons on key fob		Single beep	Press both buttons as shown in diagram below.
Press the # button to confirm.		3 tone ascending beep	The fob will now unlock the lock.
Press the # button to finish.		Voice saying "completed"	This adds the fob to the lock memory







Delete Previously Paired Key Fob

If a key fob is lost or stolen it can be removed from the lock so that it can no longer be used to open it.

Step	Icon	Expected Feedback	Description
Press any button			Press any button on the keypad to begin
Enter the master code, followed by # key	 	2 tone beep	If you have forgotten the master code please see the resetting the lock section of the manual.
Select the [3] button followed by # key	 	2 tone beep	You are now in the lock's menu, option 3 contains the key fob settings
Press the [2] button followed by # key	 	2 tone beep	This puts the lock into fob delete mode.
Enter the slot number for the fob followed by #	 	2 tone beep, then 3 tone ascending beep	Select the number of the slot in memory where the fob is saved (1-5)
Press the # button to finish.		Voice saying "completed"	The fob will now not unlock the lock.





Change PIN Relock Time

The relock time is the amount of time it takes for the external handle to disengage after the lock has been unlocked with a correct PIN. The default is 7 seconds.

Step	Icon	Expected Feedback	Description
Press any button			Press any button on the keypad to begin
Enter the master code, followed by # key		2 tone beep	If you have forgotten the master code please see the resetting the lock section of the manual.
Select the [6] button followed by # key		2 tone beep	You are now in the lock's menu, option 6 contains the key fob settings.
Input the relock time (7-60)			The relock time can be between 7 and 60 seconds.
Press the # button to finish.		Voice saying "completed"	The relock time will now be set.









Change Remote Relock Time

The lock can be set to unlock for longer periods of time unlocked remotely by a key fob or a home automation system.

Step	Icon	Expected Feedback	Description
Press any button			Press any button on the keypad to begin
Enter the master code, followed by # key		2 tone beep	If you have forgotten the master code please see the resetting the lock section of the manual.
Select the [7] button followed by # key		2 tone beep	You are now in the lock's menu, option 7 contains the key fob relock settings
Input the relock time (10-90)			The relock time can be between 10 and 90 seconds.
Press the # button to finish.		Voice saying "completed"	The relock time will now be set.

Silent Mode On/Off

The lock can be toggled between two modes. Sound assisted mode will provide a variety of sounds to provide feedback from the lock, where as in the default silent mode the only sounds will be an alarm, a low battery warning and feedback while changing settings in the lock's menu.

Step	Icon	Expected Feedback	Description
Press any button			Press any button on the keypad to begin
Enter the master code, followed by # key	 	2 tone beep	If you have forgotten the master code please see the resetting the lock section of the manual.
Select the [8] button followed by # key	 	2 tone beep	You are now in the lock's menu, option 8 contains the silent mode settings.
Press [1] to for silent mode and [2] for sound assisted mode.	 		Select between the two modes
Press the # button to finish.		Fanfare sound and voice saying "silent mode on/off"	

Smart Home Lock Module





The Yale Keyfree lock can have a removable wireless communication module within the lock. This module is used for all wireless communications to both home automation systems and key fobs. In order to connect to a home automation system a new module may be required for the lock, however changing the module has the potential to disrupt the current wireless communications. For instance while a new module may allow the lock to connect to a home automation system, it could cause the key fob to stop working. An up to date list of compatible home automation systems and the corresponding lock modules is available at the following address on the Yale website:

www.yale.co.uk/en/yale/couk/smart-lock/Which-technology-is-for-me/





Removing the module.

To find out which module is currently in your lock please follow the 'removing a module' instructions.

Step	Icon	Description
Remove inside cover		Slide up the black plastic cover of the lock on the inside of the door.
Remove a battery from the lock		Remove any of the batteries to cut power to the lock.
Remove the module		The module is situated in the top left corner above the [P] button. It can be unplugged by pulling it out.
Record module model number		The model number will be on a sticker on the module, and will enable you to find the current wireless compatibility of the lock.





Inserting a Module

Step	Icon	Description
Remove inside cover		Slide up the black plastic cover of the lock on the inside of the door.
Remove a battery from the lock		Remove any of the batteries to cut power to the lock.
Insert the module		The module has 8 pins that are plugged into the small black connector above the [P] button on the top left of the lock.

Smart Home





Connecting to a Home Automation System

Connecting to a home automation system is a two way process and may require the home automation system to be configured to look for a new device, please consult the manual that came with the system for more information.

Step	Icon	Expected Feedback	Description
Press any button			Press any button on the keypad to begin
Enter the master code, followed by # key		2 tone beep	If you have forgotten the master code please see the resetting the lock section of the manual.
Press the [4] button followed by # key		2 tone beep	You are now in the lock's menu, option 4 contains the home automation settings
Press the [1] button followed by the hash key		2 tone beep	This will make the lock look for a compatible system
Please wait up to 60 seconds		Voice saying "completed"	The lock will now be linked to the home automation system.

Disconnecting from a Home Automation System

For security reasons a lock will not connect to a new home automation system if it is linked to another. If you have changed your home automation system please run through the disconnecting settings before adding the new one.

Step	Icon	Expected Feedback	Description
Press any button			Press any button on the keypad to begin
Enter the master code, followed by # key		2 tone beep	If you have forgotten the master code please see the resetting the lock section of the manual.
Press the [4] button followed by # key		2 tone beep	You are now in the lock's menu, option 4 contains the home automation settings
Press the [2] button followed by the hash key		2 tone beep. Completed.	This will disconnect the lock from the previous system

Extra Features

Child Safety Mode

With child safety mode activation alarm activated, depressing inside handle will sound the alarm for 10 seconds to notify the door is open to any persons inside. Inputting your pin or pressing the key fob will cancel the alarm. If required the mode will then need to be activated.

Step	Icon	Description
Press and hold the passage mode button for 5 seconds.	 HOLD	Open the battery cover then press and hold the passage mode button for 5 seconds to activate the child safety mode. Replace the battery cover.





Passage Mode

When passage mode is active, the outside handle will not relock allowing you to enter without entering the code.

Step	Icon	Description
Press the passage mode button		Open the battery cover and press the P button. You will hear the lock unlock. NOTE: The lock will remain insecure until passage mode has been stopped. To stop passage mode press the passage mode button or lift the handle.

Handle Alarm

When the handle alarm is set, any operation of the handle from inside will sound the alarm for 3 minutes.
Inputting in your PIN or by pressing your key fob will disable the handle alarm setting.

Step	Icon	Description
Press any button		Press any button.
Enter PIN code		Enter the registered PIN code in the keypad.
Press and hold the  for 5 Sec.	 HOLD	Press the [#] button for 5 seconds. (The beeping sound sets off for 3 times.)

Extra Features

Intrusion Alarm

Damage Alarm :

If the circuit board of outer handle is damaged the alarm will sound.

Or if the front handle is seperated from the door.

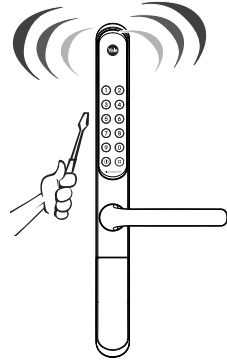

Extra Features

Incorrect PIN Lockout

For security if the wrong PIN is entered 5 consecutive times the lock will lockout for 3 minutes. This is indicated by the lights on the keypad flashing.

To Release Lockout

Method **1** Press any button inside of battery cover.

Method **2** Depress inside lever handle.

Method **3** Press any key fob button.

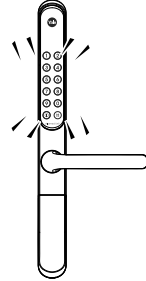





Emergency Power

Emergency Power Supply for Discharged Batteries

If the batteries in the lock have completely failed emergency power can be provided by a 9V battery on the front body.

To Supply Emergency Power

Step	Icon	Description
Contact the 9V battery		Open the emergency cover. Keep contacting the 9V battery onto the emergency power supply terminal.
Press any button		Press any button
Enter PIN code		Enter the registered PIN code in the keypad.
Press Enter button		Press  button to activate the outer handle.

Expiry Period

The product uses four 1.5V(LR6) alkaline AA batteries. The batteries will last approximately 1 year based on the lock being used 10 times a day. (Users are advised to use authentic alkaline batteries.)

Low Battery Alarm

You must replace all 4 batteries for the following cases:

- * The Low Battery LED on the back body flickers red.
- * The voice guide sounds (“Low Battery”)

RISK OF EXPLOSION IF BATTERY IS REPLACED BY AN INCORRECT TYPE. DISPOSE OF USED BATTERIES ACCORDING TO THE WASTE BATTERIES REGULATIONS.

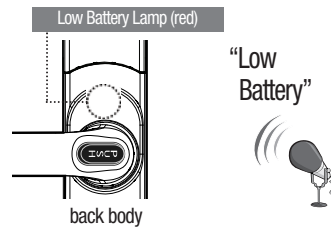







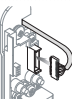

back body

The battery life varies according to ambient temperature, humidity, frequency of use and the quality of the battery. Do not use rechargeable batteries. Only alkaline batteries are recommended.

Resetting the Lock

In the event of losing the master code to the lock, the lock will need to be reset back to factory default settings. This will mean that all previously configured user codes, key fobs and home automation systems will stop working. It will also result in the master code being set to the factory default which is '123456'

Step	Icon	Description
Remove inside cover		Slide up the black plastic cover of the lock on the inside of the door.
Remove a battery from inside the lock. Then remove the module.		Take out any battery to remove the power from the lock.
Unscrew the two screws on the back to remove the rear cover.		The top screw is located below the [I] and [P] buttons while the bottom screw is behind the rubber plug under the speaker hole.
Disconnect the cable that runs to the exterior half of the lock.		Disconnect the cable that runs through the door to the exterior unit.
Press and hold the [I] button and [P] button. Continue holding the buttons and insert battery.		Continue holding these buttons until the ready sound is heard in step 6.
Wait for 10 seconds, a two tone sound will be heard.		
Release the [I] and [P] buttons		
Within 5 seconds of the two tone sound reconnect the cable running to the exterior escutcheon. The lock will play a three tone ascending tone and say "welcome to the Yale digital world" the master code is now set to 123456.		

Specifications

Specifications

Parts	Specifications	Remarks
Front (Front Body)	35mm(W) × 355mm(H) × 22mm(D) Zinc die-casting	Operating temperature : -15~55°C (5~131° F)
Back (Main Body)	35mm(W) × 355mm(H) × 40mm(D) Zinc die-casting	Operating Temperature -15°C - 55°C (5-131° F)
Lever	Zinc die-casting	
Battery	4EA 1.5V AA alkaline batteries (Operating voltage: 4.5 ~ 6 V)	Lasts approximately 1 year (when lock is used 10 times a day)

※ Battery life may vary depending on temperature, moisture levels, frequency of use and the quality of the batteries.

Contact Details

Keyfree Helpine:
01902 364606

Email:
smartlocks@yale.co.uk

Website:
www.yale.co.uk



WEEE Note:
Waste electrical products should not be disposed of with household waste. Please recycle where facilities exist. Check your local authority or retailer for recycling advice.



Warranty



2 Year Guarantee Statement

This product is guaranteed for consumers against faulty workmanship, materials and function for a period of 2 years from the date of purchase providing the full installation and maintenance instructions are followed. Please keep your proof of purchase safe, this must be submitted when making a claim under this guarantee.

Please note that it is a condition of this guarantee that your Yale product:

- Has been correctly installed and maintained in accordance with the Yale installation and maintenance instructions provided to you at the time of purchase.
- Has not been modified or damaged in any way.
- Has not been subjected to unauthorized repairs.

Yale are responsible under this guarantee for repairing the product or replacing the product as we deem necessary. If there is fault with the product, please contact Customer Services on 01902 364647, who will give you the name of an expert and confirm what you need to do to make a claim under this guarantee.

Please do not carry out any repairs without our authority or by using an unauthorised expert. Any repairs or other works carried out without our authorization or by using an unauthorized expert will not be covered under this guarantee.

This guarantee is non transferrable and applies to products purchased in the United Kingdom only. This guarantee does not apply to normal wear and tear. This does not affect your statutory rights. A full copy of this guarantee is available upon request by writing to Yale UK, School Street, Willenhall, West Midlands. WV13 3PW or by visiting our website www.yale.co.uk.

User Code Log

Pin Codes

Slot Number	Name	Pin Code (Optional)
1		
2		
3		
5		
6		
7		
8		
9		
10		
11		
12		
13		
14		
15		
16		
17		
18		
19		
20		

Key Fob Log

Key Fob

Slot Number	Name
1	
2	
3	
4	
5	