



User's Guide

YDM4109



GATEMAN
Digital door locks

INTRO

To get peace of mind, you need to secure yourself, your home and your personal belongings. Yale Digital Door Locks take care of all this so that you can enjoy your life without any worries. In these products we have combined our long experience in making secure and reliable locks with the latest technology for convenience and safety.

With all the functions for convenience and safety, Yale Digital Door Locks clearly offer you more than just security. In addition to this, we have also put a lot of effort in the aesthetic design of these products, so that your Yale Digital Door lock can actually enhance the appearance of your door while securing it at the same time.

The future of locking is already here and ready for use. Get rid of all your concerns regarding the security of your home and use a Yale Digital Door Lock to unlock the door to the potential of your life.

Unlock your life!

<http://www.yalegateman.com>

The world's favorite lock



CONTENTS

Getting Started

Safety Cautions	4
Product Features	5
Simplified Directions	6

Directions

Directions	10
Components Overview • Identification	
How to Use	12
Master Number	
Password	
Fingerprint Guide	
Normal Mode: Use Fingerprint	
Security Mode: Use Fingerprint	
Remove Fingerprint	
Lock Door	
Open Door from Inside	
Settings	20
Safe Handle Feature • Volume Setting Feature	
Auto / Manual Feature • Change to Fingerprint Mode	
Voice / Melody Feature • Language Setting	
Forced Lock	
Safety Feature	25
Alarm Feature	
3-minute Lock Feature • Open Door with false PIN code	

Extra Features

Option	28
Remote Control Module	
Remote Control	
Customer Service	30
Emergency Power Supply for Discharged Batteries	
Customer Service Request for Product Errors	
Product Specification	58

Safety Cautions

Must Read This!!!

Please read this carefully for your own safety.

Do not install the unit in outdoor environment.



Be careful not to let unauthorized user know your PIN Code.



An infant and some users who have unusual fingerprints (those which are difficult to register) may not be registered for fingerprint verification.



※ Scan-type fingerprint modules do not recognize fingerprints with water or foreign materials and set off alarm sounds.

Do not use force with a tool onto the product.



Please keep your password safely.



Make sure to lock the door tight when you go out.



Be careful not to hit the handle as it may cause injuries.



Keep foreign materials away from the fingerprint sensor to maintain it cleanly and do not use it with wet fingers.

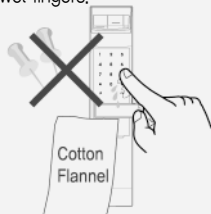

Do not spray water directly to the product or wipe it with chemical substances such as benzene, thinner, or alcohol when cleaning the product.



Caution

Make sure to follow the above instructions to avoid any injuries or damages on the properties .

Product Features

1 One-touch Fingerprint Verification Method (Easy Scan)

Easy Scan technology has been applied to conveniently read a fingerprint in one shot without the need to open or close the cover to enter a fingerprint.

2 SHM(Safe Handle Mechanism) Technology

SHM(Safe Handle Mechanism) Technology that makes it impossible to open the Doorlock to trespass a house by drilling a hole on the entrance or through a pet door has been applied.

3 Palm Touch Feature

To prevent the password from being exposed due to residual fingerprints after opening a door, a new technology has been adopted to complete the door opening process by touching the keypad with a palm after entering the password.

4 Smart Pad Feature

A separate lighting method where each keypad number has been separately designed is applied so that users may examine intuitively how the selected function is operated and if they are run normally.

5 Voice Guide Feature

As the voice guide is offered that lets you know the operation status and how to set each feature and mode for easier and more convenient use.

6 Yale GATEMAN Networking System (Option)

You may use a remote control by installing the Remote control Module. It enables you to link it with the Network package – a wireless security system.

Simplified Directions

1 Register Password

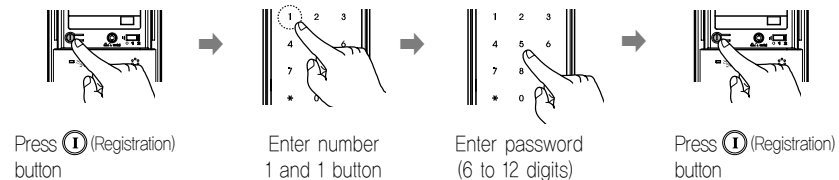

2 Register Master Number

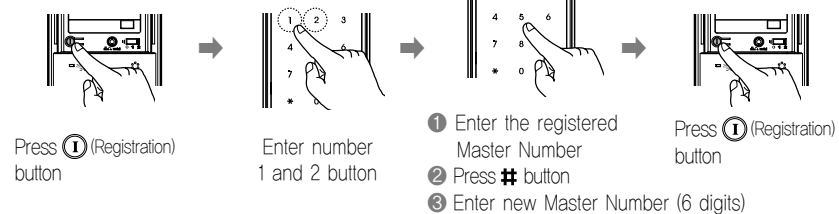

3 Set Normal Mode (Fingerprint)

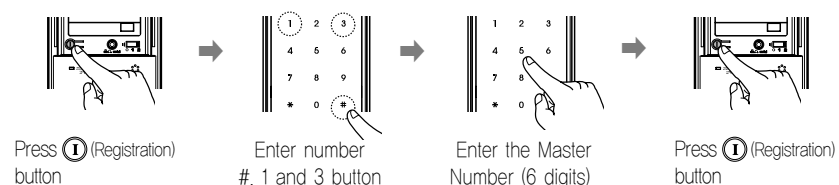

4 Set Security Mode (Fingerprint)

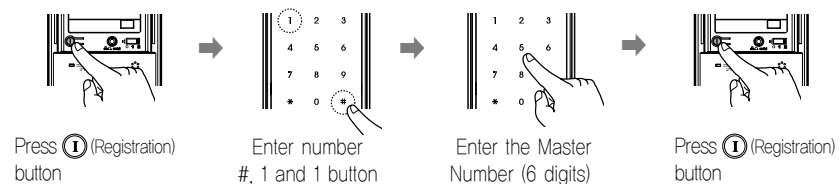

Simplified Directions

5 Register Fingerprints (Normal Mode)

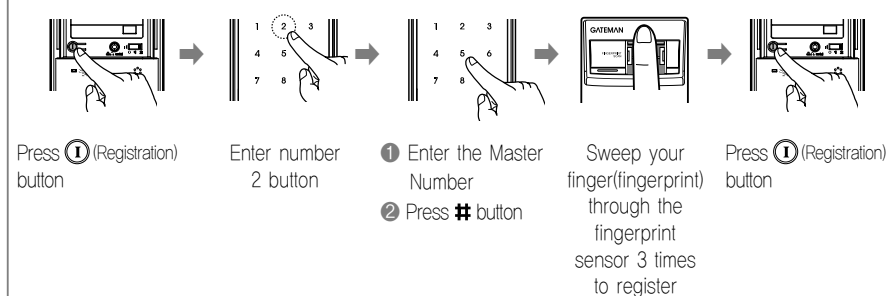

6 Register Fingerprint (Security Mode)

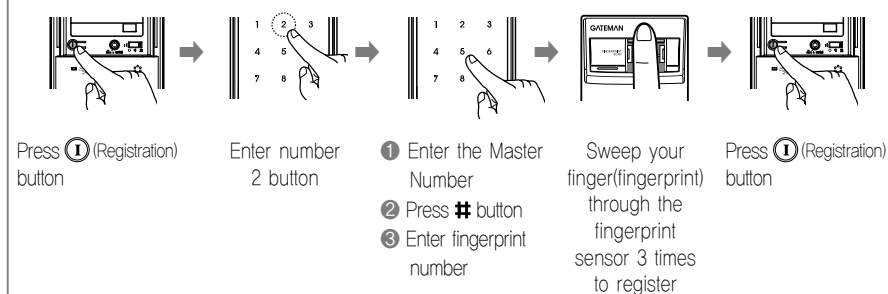

⚠ Caution

- The default Master Number is '1 2 3 4 5 6'.
- It is advised to register the Master Number with the same one as a password in case you lose it.

Simplified Directions

7 Lock Door from Outside

- ① If you close a door in Auto Lock status, it will be closed within 5 seconds by the automatic lock sensor.
- ② In Manual Lock status, touch the keypad in the front body (Front Body) gently with your palm to lock a door.

8 Open Door from Outside

- ① Sweep a registered fingerprint through the fingerprint sensor.
- ② Touch the keypad in the front body gently with your palm to press the registered password. And then, press the keypad again gently with your palm or press * button to end.

9 Lock/Open Door from Inside

- ① Turn the manual open/close device. The deadbolt will open and close in turn.
- ② If Auto Lock is set, a door will automatically be closed once closed.
- ③ Press the Safe Handle button and lower the handle to open a door.



10 Set Auto/ Manual Mode

Press the Auto/Manual Lock Setting button in the back body to keep the button up.

Press the Auto/Manual Lock Setting button in the back body to keep the button down.

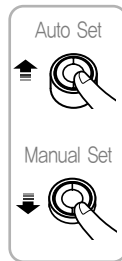

7 Emergency mechanical key override

Please operate the lock with the mechanical key when there is a problem to the lock or unlock the door that is the same as below listed.

- Forgotten security code
- Electronic malfunction

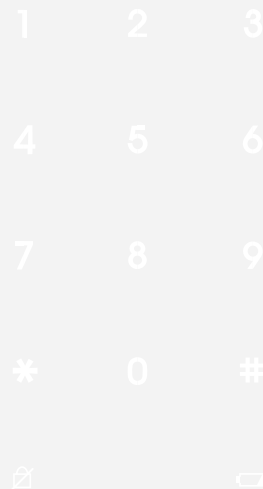
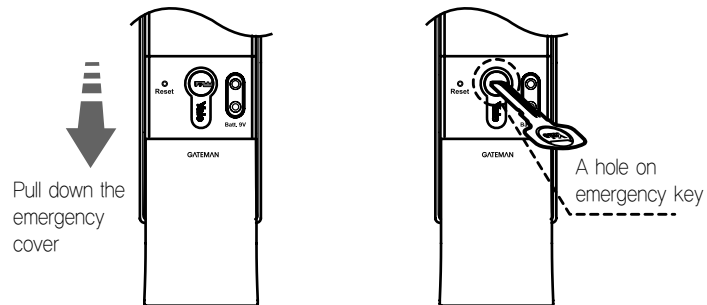

Directions

Directions 10

Components Overview • Identification

How to Use 12

- Master Number
- Password
- Fingerprint Guide
- Normal Mode: Use Fingerprint
- Security Mode: Use Fingerprint
- Remove Fingerprint
- Lock Door
- Open Door from Inside

Settings 20

- Safe Handle Feature • Volume Setting Feature
- Auto / Manual Feature • Change to Fingerprint Mode
- Voice / Melody Feature • Language Setting
- Forced Lock

Safety Feature 25

- Alarm Feature
- 3-minute Lock Feature • Open Door with false PIN code

Components Overview

Basic Contents

The contents of this product may be subject to change without notice for performance or quality improvement.

» Basic Contents

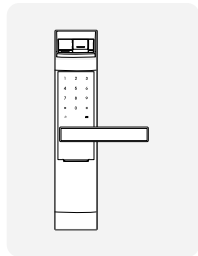

Front (Front Body)

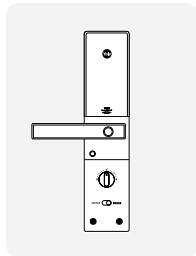

Back (Main Body)

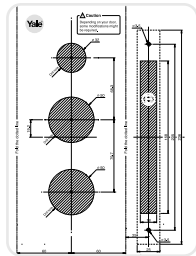

Installation Template

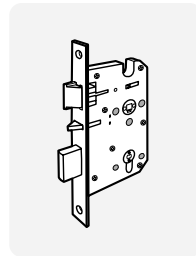

Lock case

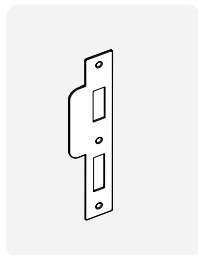

Strike Plate



Users Guide

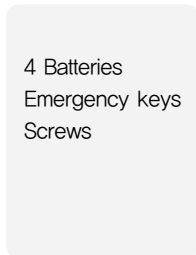

4 Batteries
Emergency keys
Screws

» Option

- Remote control
- Remote control module

Identification

Front

(Front Body, install on the outside of the door)

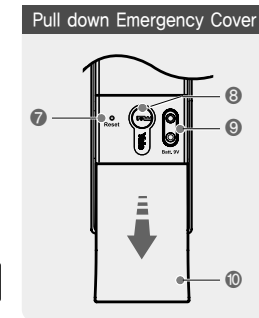
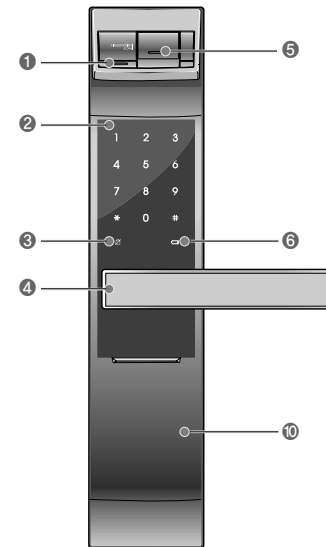

1	Fingerprint Operation Lamp
2	Keypad (10-Key)
3	Dead Bolt Jam Lamp
4	Lever
5	Fingerprint Cover
6	Battery Change Lamp
7	Reset button
8	Emergency Key
9	Emergency Power Supply Terminal
10	Emergency Cover

Back

(Back Body, install on the inside of the door)

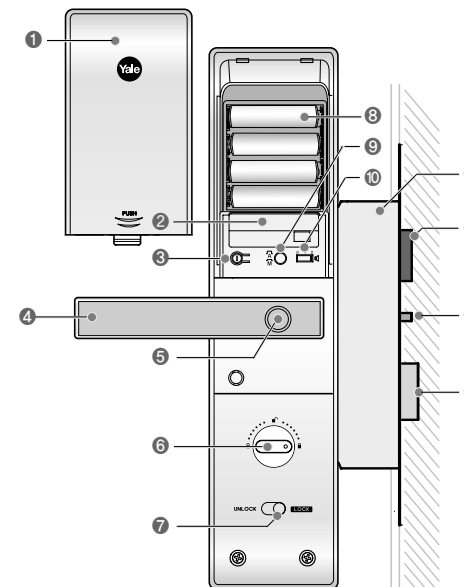











1	Battery Cover
2	Slot for Remote control module(Optional)
3	Ⓜ Registration button
4	Lever
5	Safe handle button
6	Manual thumb turn
7	Internal Forced Lock Switch
8	1.5V AA Alkaline Batteries
9	Auto / Manual Lock button
10	Volume Control Switch
11	Lock case
12	Latch Bolt
13	Automatic Locking Sensor
14	Dead Bolt

How to Use

To Use Master Number

>> To Register Master Number

Order	Play	Description
1 Press  (Registration) button		Open the battery cover in the back body and press  (Registration) button once.
2 Enter number 1 and 2 button		Press the number 1 and 2 according to the voice guide.
3 Enter the registered Master Number		Press the registered Master Number (6 digits) according to the voice guide. (The default Master Number is '1 2 3 4 5 6')
4 Enter  button		Press # button.
5 Enter a new Master Number to register		Press a Master Number (6 digits) to register according to the voice guide.
6 Press  (Registration) button		Press the  (Registration) button in the back body again to complete the Master Number registration.

To use Master Number

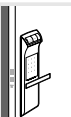

- The Master Number is required to register or remove a fingerprint.
- If you forget the Master Number, you may not register or remove a fingerprint.

Note







- The default Master Number is '1 2 3 4 5 6'.
- It is advised to register the Master Number with the same one as a password in case you lose it.

How to Use



To Use Password

Passwords should be selected from 6 to 12 digits, [*] and [#] are not allowed.

>> To Register Password

Order	Play	Description
1 Press  (Registration) button		Open the battery cover in the back body and press  (Registration) button once.
2 Press number 1, 1 button ➔ Enter the password		Press the number 1, 1 button and then the password on the keypad according to the voice guide. (6 to 12 digits)
3 Press  (Registration) button		Press the  (Registration) button in the back body again to complete the password registration.

>> To Open Door with Password

Order	Play	Description
1 Touch with palm		Touch the keypad of the front body gently with your palm.
2 Enter password		Enter the registered password in the exterior number plate.
3 Touch with palm		Touch the keypad of the front body gently with your palm or press [*] button to end.

Note

- Make sure to leave the door open when registering a password because you may accidentally lock a door while trying to register or change a password the first time.
- The previously registered password will automatically be deleted when the new password is registered.
- When registering a password, the registered password will be displayed on the keypad (Smart Pad) in sequential order and, then, be disappeared.

How to Use

Fingerprint

» Fingerprint Guide

To change modes: Please refer to page 19.

Normal Mode : It enables you to make separate registration, and open a door through the registered fingerprint or password.

Security Mode : It enables you to make separate registration and deletion, and open a door only when the fingerprint number and the fingerprint match.

Repeated Operations

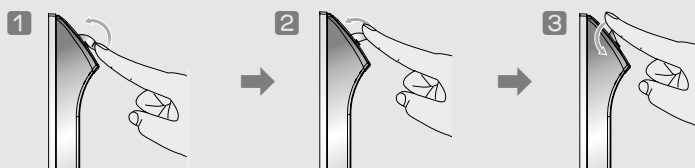

1 Press and lift up the Guide Bar on the fingerprint cover.

2 You will see the fingerprint cover being raised and start to open.

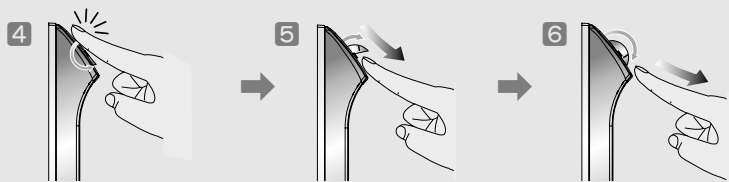

4 When the fingerprint cover is completely open, the lamp will be on.

5 Start sweeping your fingerprint through the sensor.

6 Complete your fingerprint registration.

Note

- You may register up to 20 fingerprints. (The same applies to Normal/Security Mode)
- ※ Note that you may not register 20 fingerprints depending on the state of the previously registered fingerprints.
- Scan-type fingerprint modules do not recognize fingerprints with water or foreign materials and set off alarm sounds.
- Make sure to register a password just in case you fail to register a fingerprint.
- Make sure to leave the door open when registering a password because you may accidentally lock a door while trying to register or change a password the first time.
- If an error occurs during registration, the process reverts back the beginning (entering fingerprint).
- If no more input is made for 20 seconds after registering at least 1 fingerprint, the registration will be complete.
- Duplicate fingerprints may be registered. • Same fingerprints can be registered repeatedly.

How to Use

Normal Mode: Use Fingerprint

It enables you to make separate registration, and open a door through the registered fingerprint or password.

» To Register Fingerprint

Order	Play	Description
1 Press I (Registration) button		Open the battery cover in the back body and press I (Registration) button once.
2 Press number 2 button → Enter the Master Number → Enter # button		Press the number 2 button according to the voice guide. Press the Master Number and then the [#] button on the keypad.
3 Register fingerprint - 3 times		After the operation lamp is on, sweep your fingerprint 3 times through the fingerprint sensor according to the voice guide.
4 Press I (Registration) button		Press the I (Registration) button in the back body again to complete the fingerprint registration. (Press [#] button to continue the fingerprint registration process.)

» To Open Door with Fingerprint

Order	Play	Description
1 Lift the fingerprint cover open		Lift open the fingerprint cover and wait for the operation lamp to light on.
2 Enter fingerprint		Sweep the registered fingerprint through the fingerprint sensor in the front body.

Check if a door opens!











Make sure to examine if the door opens normally with the registered password or fingerprint after the registration is complete.

How to Use



Security Mode: Use Fingerprint

It enables you to make separate registration and deletion, and open a door only when the fingerprint number and the fingerprint match

» To Register Fingerprint

Order	Play	Description
1 Press  (Registration) button		Open the battery cover in the back body and press  (Registration) button once.
2 Press number 2 button ➔ Enter the Master Number ➔ Enter # button		Press the number 2 button according to the voice guide. Press the Master Number and then the [#] button on the keypad.
3 Press fingerprint number		Enter 4-digit fingerprint number to register.
4 Register fingerprint – 3 times		After the operation lamp is on, sweep your fingerprint 3 times through the fingerprint sensor according to the voice guide
5 Press  (Registration) button		Press the  (Registration) button in the back body again to complete the fingerprint registration. (Press [#] button to continue the fingerprint registration process.)

» To Open Door with Fingerprint







Order	Play	Description
1 Touch with palm		Touch the keypad of the front body gently with your palm.
2 Press fingerprint number		Enter the registered fingerprint number in the keypad.
3 Enter fingerprint		Sweep the registered fingerprint through the exterior fingerprint sensor.

How to Use









Remove Fingerprint

You may only delete each fingerprint separately in the Security Mode.

» To Delete All Fingerprints

Order	Play	Description
1 Press  (Registration) button		Open the battery cover in the back body and press  (Registration) button once.
2 Press number 3 button ➔ Enter the Master Number		Press the number 3 according to the voice guide and then, the Master Number on the keypad.
3 Press  (Registration) button		Press the  (Registration) button in the back body again to delete all fingerprints.

» To Delete Each Fingerprint

Order	Play	Description
1 Press  (Registration) button		Open the battery cover in the back body and press  (Registration) button once.
2 Press number 4 button ➔ Enter the Master Number ➔ Enter the #		Press the number 4 according to the voice guide and then, the Master Number and [#] on the keypad.
3 Registered fingerprint number		Enter the fingerprint number to delete on the keypad.
4 Press  (Registration) button		Press the  (Registration) button in the back body again to delete a single fingerprint.

How to Use

Open Door from Inside

The default setting is Safe Handle Setting.

➤ To Open Door from Safe Handle Setting

Keep pressing the Safe Handle button. And then, lower and push the handle at the same time. The Safe Handle button is found on the interior handle.

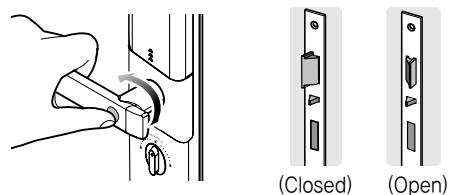

➤ To Open Door from Safe Handle Setting Released

Lower and push the interior handle at the same time.

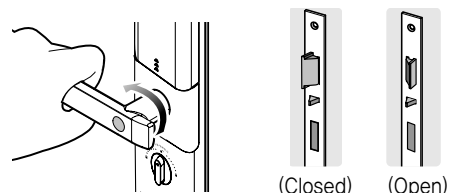

➤ To Open with Manual Device for Emergencies

Turn the Manual thumb turn to Open side. Keep pressing the Safe Handle button. And then, lower and push the handle at the same time. The Safe Handle button is found on the interior handle.

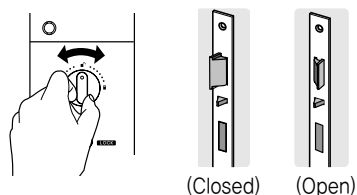

Note

- Make sure to fully familiarize yourself with the operations for the Manual Device and the Safe Handle in preparation for emergencies.

How to Use

Lock Door

➤ To Close Door from Outside

Order	Play	Description
Auto Lock status	5 Sec	The built-in Auto Lock sensor automatically locks a door within 5 seconds after the door was closed.
Manual Lock status		Touch the keypad in the front body gently with your palm to lock a door.

➤ To Close Door from Inside

Order	Play	Description
Auto Lock status	5 Sec	The built-in Auto Lock sensor automatically locks a door within 5 seconds after the door was closed.
Manual Lock status		Turn the Manual Open/Close Device to Close side to lock a door.

Note

- Even after a door was locked by the Auto Lock function, please check again if the door was completely closed and locked.

Settings

Safe Handle Feature

The technology to prevent a forced attempt to drill a hole in the door and unlock the Doorlock has been applied.

>> To Release Safe Handle Setting

- 1 Open the battery cover and take out a hex wrench.
- 2 Keep pressing the Safe Handle button. Turn the set bolt found in next to the handle to Close side.

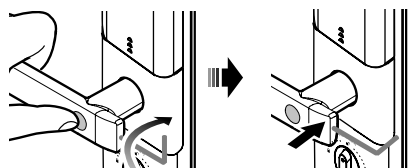

>> To Set Safe Handle

- 1 Open the battery cover and take out a hex wrench.
- 2 Turn the set bolt found in next to the handle to Open side until the Safe Handle button comes out.

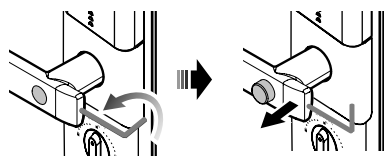

Volume Setting Feature

It enables you adjust the volume of various sounds from the product.

>> Volume Setting

Order	Play	Description
To set volume switch		The operation sound volumes are adjusted according to the Volume Switch Setting. (2 : Louder / 1 : Lower / 0 : Mute)

Note

- Be careful that the set bolt won't detach when modifying the Safe Handle Setting.
- Even when the operation sound is set as 'Mute,' the error and alarm sounds will go off.

Settings

Auto / Manual Feature

Auto Lock setting locks a door within 5 seconds after the door was closed.

>> To Set Auto/Manual Feature

Order	Play	Description
Auto Lock Setting		Press the interior Auto/Manual Setting button to keep the button up.
Manual Lock Setting		Press the interior Auto/Manual Setting button to keep the button down.

Change to Fingerprint Mode

The default setting is Normal Mode.

>> Fingerprint Mode Setting

Order	Play	Description
1 Press (Registration) button and button		Open the battery cover in the back body. Press (Registration) button and then, button.
Security Mode Setting Press number 1 and 1 button ➔ Enter the Master Number		Press the number 1 and then, 1 again on the keypad. Enter the registered Master Number.
Normal Mode Setting Press number 1 and 3 button ➔ Enter the Master Number		Press the number 1 and then, 3 again on the keypad. Enter the registered Master Number.
2 Press (Registration) button		Press (Registration) button again to set Security Mode or Normal Mode.

Note







- Even after a door was locked by the Auto Lock function, please check again if the door was completely locked.
- It is advised to keep the fingerprint exclusive number(4 digits) as a separate list just in case for a separate fingerprint deletion at Security Mode.
- If more than 1 fingerprint is registered after the Security Mode is set, you may not open a door with a password. (If the fingerprint module is broken, you may use a password.)

Settings

Voice / Melody Feature

You may select the operation sound that is set off when a door is open and closed.







> To Set Voice/Melody Feature

Order	Play	Description
1 Press  (Registration) button and # button		Open the battery cover in the back body. Press  (Registration) button and then, [#] button.
2 Enter number 2 and 2 on the keypad		Enter the number 2 and then, 2 again on the keypad.
3 Press  (Registration) button		Press  (Registration) button again in the back body.

Language Setting

English and Chinese languages are supported.



> Language Setting

Order	Play	Description
1 Press  (Registration) button and # button		Open the battery cover in the back body. Press  (Registration) button and then, [#] button.
2 Enter number 2 and 3 on the keypad		Enter the number 2 and then, 3 again on the keypad.
3 Press  (Registration) button		Press  (Registration) button again in the back body.



Settings

Forced Lock

> Outside Forced Lock Setting – Fingerprint

Order	Play	Description
1 Enter fingerprint		Enter the registered fingerprint on the fingerprint sensor when the operation lamp(LED) is on.
2 Press # button for 5 seconds		Press the [#] button for 5 seconds. (A beeping sound sets off for 3 times.)

> Outside Forced Lock Setting – Password

Order	Play	Description
1 Touch with palm		Touch the keypad of the front body gently with your palm.
2 Enter password		Enter the registered password in the exterior number plate.
3 Press # button for 5 seconds		Press the [#] button for 5 seconds. (A beeping sound sets off for 3 times.)

> Inside Forced Lock Setting

Order	Play	Description
Set / Release Inside Forced Lock Switch		When the door is closed, move the Inside Forced Lock Switch to LOCK position so that a red sticker can be seen.

Note

- If you try to open a door with the handle or the Manual Open/Close Device from inside when the Outside Forced Lock is set, the alarm goes off.
- If the Inside Forced Lock is set, any attempt to open a door from outside whether it'd be a fingerprint or a password won't work.
- When setting the Outside/Inside Forced Lock, enter the number on the keypad (Smart Pad) and the numbers will flicker from left to right one by one and repeat twice.

Settings

Alarm Feature

The alarm sound continues for 30 minutes or until it is reset.

» Break-in / Damage Alarm

Break-in: When someone tries to Break-in by opening a door when it was locked, the alarm will go off.

Damage: When the front body was damaged due to forced separation or drilling, the alarm will go off.

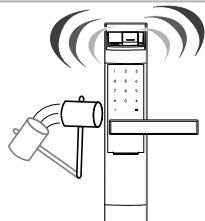

Release Trespass/Damage Alarm

- Method ① Enter the registered password.
- Method ② Enter the registered fingerprint.
- Method ③ Press the interior ① button for 5 seconds.

Note

- If a door is open when the Auto Lock is not properly operated, the Break-in alarm might go off.
- If the alarm goes off due to damage, fire, or break in, the numbers on the keypad will light up clockwise. (It repeats the status for 30 minutes with alarm sound.)

Safety Feature

3-minute Lock Feature

At 3-minute Lock mode, no button, besides those in the back body, will work.

» 3-minute Lock Mode Display

- If a password or a fingerprint that is yet to be registered is entered for 5 consecutive times, 3-minute Lock mode is on and nothing will work for 3 minutes.

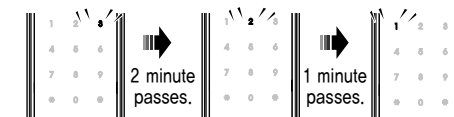

To Release 3-minute Lock

- Method ① Press the interior ① button.
- Method ② Turn the interior handle.

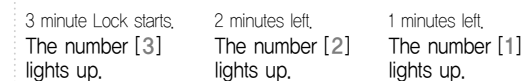

Open Door with false PIN code

It is the most effective feature when you are concerned about your password being accidentally exposed when you have company or in the similar situations.

» To Open Door with false PIN code

Order	Play	Description
① Touch with a palm		Touch the keypad with your palm gently.
② Enter the false PIN code and a password		Method ① Enter the false PIN code → password Method ② Enter the password → fake PIN code
③ Touch with a palm		Touch the keypad with your palm gently or press [*] button to end.

Note

- 3-minute Lock mode won't affect the alarm mode and is sustained even after the product is rebooted.
- Once 3-minute Lock mode is on, the fake PIN code mode won't work until the next normal verification (fingerprint verification, normal password, open door from inside). In this case, please open a door with your correct password.

Safety Feature

Emergency mechanical key override

» Emergency mechanical key override

- Please operate the lock with the mechanical key when there is a problem to the lock or unlock the door that is the same as below listed.
- Forgotten security code
- Electronic malfunction

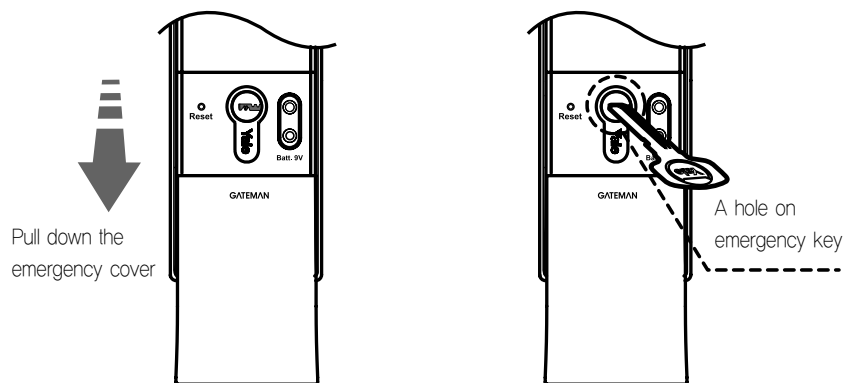

Note

- Keep the mechanical override key in a safe place.
- Otherwise, you may not get a free after-sales service even within during the warranty period.

Extra Features

Option	28
Remote Control Module	
Remote Control	
Customer Service	30
Emergency Power Supply for Discharged Batteries	
Customer Service Request for Product Errors	



Option

Remote Control Module

Buy the Remote control Module and install it to link the remote control.

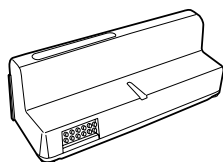

Remote control Module

» Install Remote Control Module

1 Remove batteries

Open the battery cover in the back body and remove all batteries.

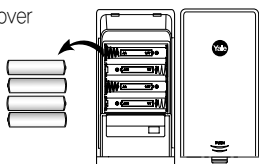

2 Install Remote Control Module

Equip the Remote control Module to the connector.

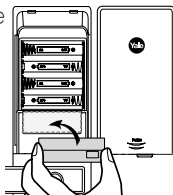

3 Insert batteries

Insert all the batteries by checking the [⊕, ⊖] connector.

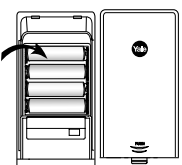

4 Confirm the installation

If you hear a 'ting-a-ling' sound, the Remote control Module has been installed correctly. Close the battery cover.

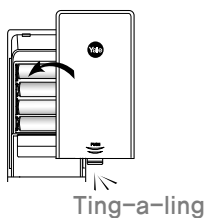

Note

- The operation status may only be examined through the remote control.

Option

Remote Control

Not only FSK method but also the wireless encryption algorithm has been applied.

» To Register Remote Control

Order	Play	Description
1 Press I (Registration) button and # button		Open the battery cover in the back body. Press I (Registration) button and then, [#] button.
2 Enter number 0 and then 5 on the keypad		Enter the number 0 and then, 5 button on the keypad.
3 Register fingerprint		Press the SET button of the remote control
4 Press I (Registration) button		Press the I (Registration) button in the back body again to complete the procedure.

» To Release Remote Control

Order	Play	Description
1 Press I (Registration) button and # button		Open the battery cover in the back body. Press I (Registration) button and then, [#] button.
2 Enter number 7 and then 5 on the keypad		Enter the number 7 and then, 5 again on the keypad.
3 Press I (Registration) button		Press the I (Registration) button in the back body again to complete the procedure.

Note





- The wireless encryption algorithm resorts to the floating ID technology where the wireless password is changed every time the remote control is operated.

Customer Service

Emergency Power Supply for Discharged Batteries

You may open a door when contacting the 9V battery.

» To Supply Emergency Power

Order	Play	Description
1 Contact the 9V battery		Open the emergency cover. Keep contacting the 9V battery onto the emergency power supply terminal.
2 Touch with a palm		Touch the keypad gently with your palm.
3 Enter password		Press each number of your password.
4 Enter * button		Press [*] button again. (Once the motor is fully operated, you may detach the 9V battery.)

» To Replace Battery

1 Expiry Period

The product uses four 1.5V alkaline AA batteries. They may sustain 1 year if used 10 times a day.

(Users are advised to use authentic alkaline batteries.)

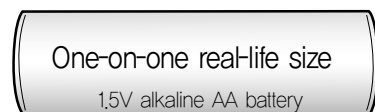

2 Low Battery Alarm

You must replace all 4 batteries for the following cases:

- * The Low Battery Lamp on the front body lights on
- * The Low Battery Lamp on the back body flickers red
- * The alarm melody goes off
(a nursery rhyme starting with ting-a-ling melodies)
- * The voice guide goes off ("Please replace batteries.")

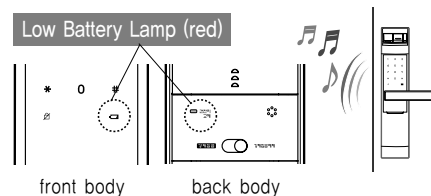

Note

- The battery duration varies in the temperature, humidity, the number of use, and the quality of the battery.